



PARTS CATALOG

MERC 90

SERIAL NUMBER

90 (6 CYL.) USA 5299506 THRU 5594656
90 (6 CYL.) AUS 8060545 THRU 8060694

TABLE OF CONTENTS:

BOTTOM COWL AND SHIFT LINKAGE	28
CARBURETOR ASSEMBLY	16
CARBURETOR LINKAGE AND CHOKE SOLENOID	14
CLAMP BRACKET AND REVERSE LOCK	34
COWLING AND FRONT COVER	4
CRANKSHAFT, PISTONS AND CONNECTING RODS	26
CYLINDER BLOCK AND CRANKCASE ASSEMBLY	22
DRIVE SHAFT HOUSING ASSEMBLY	38
END CAP, MANIFOLD AND EXHAUST COVERS	24
EXHAUST EXTENSION PLATE	30
FLYWHEEL, STARTER MOTOR AND STATOR	6
FUEL PUMP AND FUEL LINE ASSEMBLY	20
GEAR HOUSING ASSEMBLY, COMPLETE	40
GEAR HOUSING ASSEMBLY, COMPLETE	44
HYDRAULIC PUMP AND CONTROL VALVE	48
HYDRAULIC PUMP ASSEMBLY	46
MISCELLANEOUS PARTS/ACCESSORIES	1
PARTS INDEX	59
POWER TRIM CYLINDER REPAIR KITS	56
PROPELLERS (RIGHT HAND ROTATION)	58
SWIVEL BRACKET ASSEMBLY	32
THROTTLE LEVER AND LINK RODS	8
TOP COWL AND SUPPORT BRACKETS	2
TRIM CYLINDERS AND HYDRAULIC HOSES	52
WIRING HARNESS, SWITCH BOX AND IGNITION COIL	10

NOTE: Indented description indicate that these parts are included in preceding assembly.

AR = As Required

NSS = Not Sold Separate

OPT = Optional

NS = Not Shown

NOTE: Following symbols are located in **SYM** column.

● = CONTENTS OF C-[27-85653A79] GASKET SET

▲ = CONTENTS OF GASKET AND PACKING SET

■ = CONTENTS OF REPAIR PARTS KIT

THESE PARTS BOOKS/FICHE CARD ARE COPYRIGHTED AND MAY NOT BE DISTRIBUTED OR REPRODUCED IN ANY OTHER FORMAT BY ANYONE OTHER THAN MERCURY MARINE WITHOUT THE PRIOR WRITTEN CONSENT OF MERCURY MARINE.

MISCELLANEOUS PARTS/ACCESSORIES

REF. NO.	PART NO.	SYM.	QTY.	DESCRIPTION
-	90-86153		0	MERC 90 PARTS LIST
-	27-85653A79		0	GASKET SET
-	37-86432A79		0	DECAL SET

TOP COWL AND SUPPORT BRACKETS

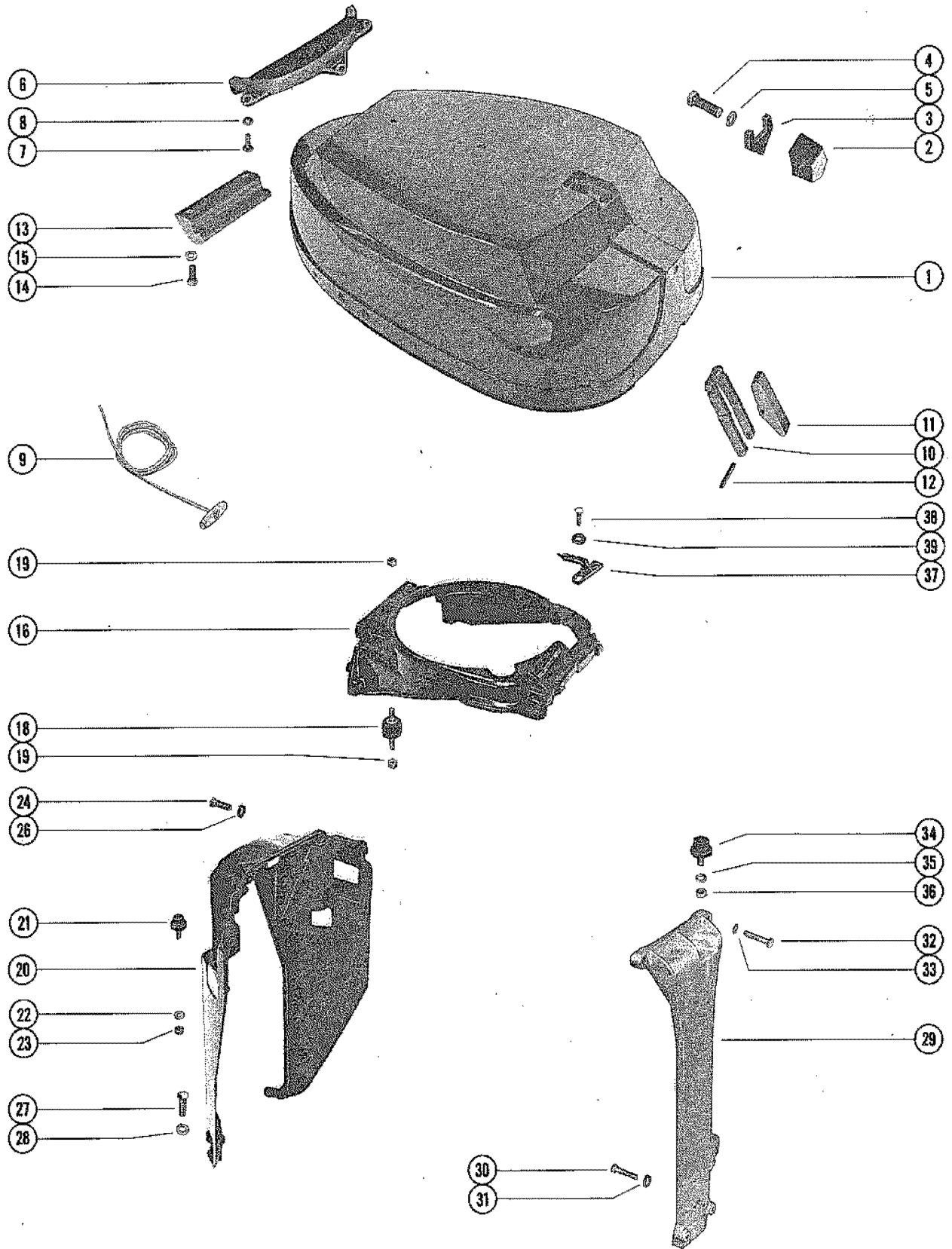

TOP COWL AND SUPPORT BRACKETS

REF. NO.	PART NO.	SYM.	QTY.	DESCRIPTION
1	2114-5999		1	COWL, TOP (WITHOUT DECALS)
2	52733A9		1	RETAINER ASSEMBLY, TOP COWL
3	35496		1	PAD, BUMPER - TOP COWL RETAINER
4	10-37558		1	SCREW, RETAINER TO TOP COWL (1 1/4")
5	13-39107		1	LOCKWASHER, RETAINER TO TOP COWL SCREW
6	76370		1	SHIELD, TOP COWL - REAR
7	10-37370		3	SCREW, SHIELD TO TOP COWL (5/8")
8	13-37371		3	LOCKWASHER, SHIELD SCREW
9	47341A1		1	ROPE, STARTER (FOR MANUAL STARTING ONLY)
10	52739		1	HINGE, COWL LATCH - TOP COWL
11	52737		1	LEVER, COWL LATCH HINGE
12	17-58998		1	PIN, ROLL - COWL LATCH LEVER TO HINGE
13	55455		1	HOOK, TOP COWL LATCH - REAR
14	10-22956		2	SCREW, REAR HOOK TO TOP COWL (7/8")
15	13-26992		2	LOCKWASHER, REAR HOOK MOUNTING SCREW
16	79897		1	FRAME, TOP COWL SUPPORT
18	63007		3	MOUNT, RUBBER - TOP COWL FRAME
	46096		OPT	MOUNT, RUBBER - TOP COWL FRAME (HEAVY DUTY)
19	11-35888		6	NUT, RUBBER MOUNT TO TOP COWL FRAME
20	86472		1	BRACKET, TOP COWL SUPPORT - REAR
21	31014		2	MOUNT, RUBBER - REAR SUPPORT BRACKET
22	13-26992		2	LOCKWASHER RUBBER MOUNT TO REAR SUPPORT BRACKET
23	11-29598		2	NUT RUBBER MOUNT TO REAR SUPPORT BRACKET
24	10-37562		4	SCREW, REAR BRACKET TO FRAME (1")
26	13-26993		4	LOCKWASHER, REAR BRACKET SCREW
27	10-37562		4	SCREW, REAR BRACKET TO BOTTOM COWL (1")
28	13-26993		4	LOCKWASHER, REAR SUPPORT BRACKET SCREW
29	77103A3		1	BRACKET ASSEMBLY, TOP COWL - FRONT
30	10-69092		2	SCREW FRONT BRACKET TO BOTTOM COWL (1 1/4")
31	13-26993		2	LOCKWASHER FRONT SUPPORT BRACKET SCREW
32	10-69092		2	SCREW FRONT BRACKET TO TOP COWL FRAME (1 1/2")
33	13-26993		2	LOCKWASHER, FRONT SUPPORT BRACKET SCREW
34	37640		1	MOUNT, RUBBER FRONT SUPPORT BRACKET
35	13-26993		1	LOCKWASHER RUBBER MOUNT TO FRONT SUPPORT BRACKET
36	11-28770		1	NUT RUBBER MOUNT TO FRONT SUPPORT BRACKET
37	87991		1	POINTER, TIMING
38	10-28636		1	SCREW, TIMING POINTER ATTACHING (3/4")
39	12-35462		1	WASHER, TIMING POINTER SCREW

COWLING AND FRONT COVER

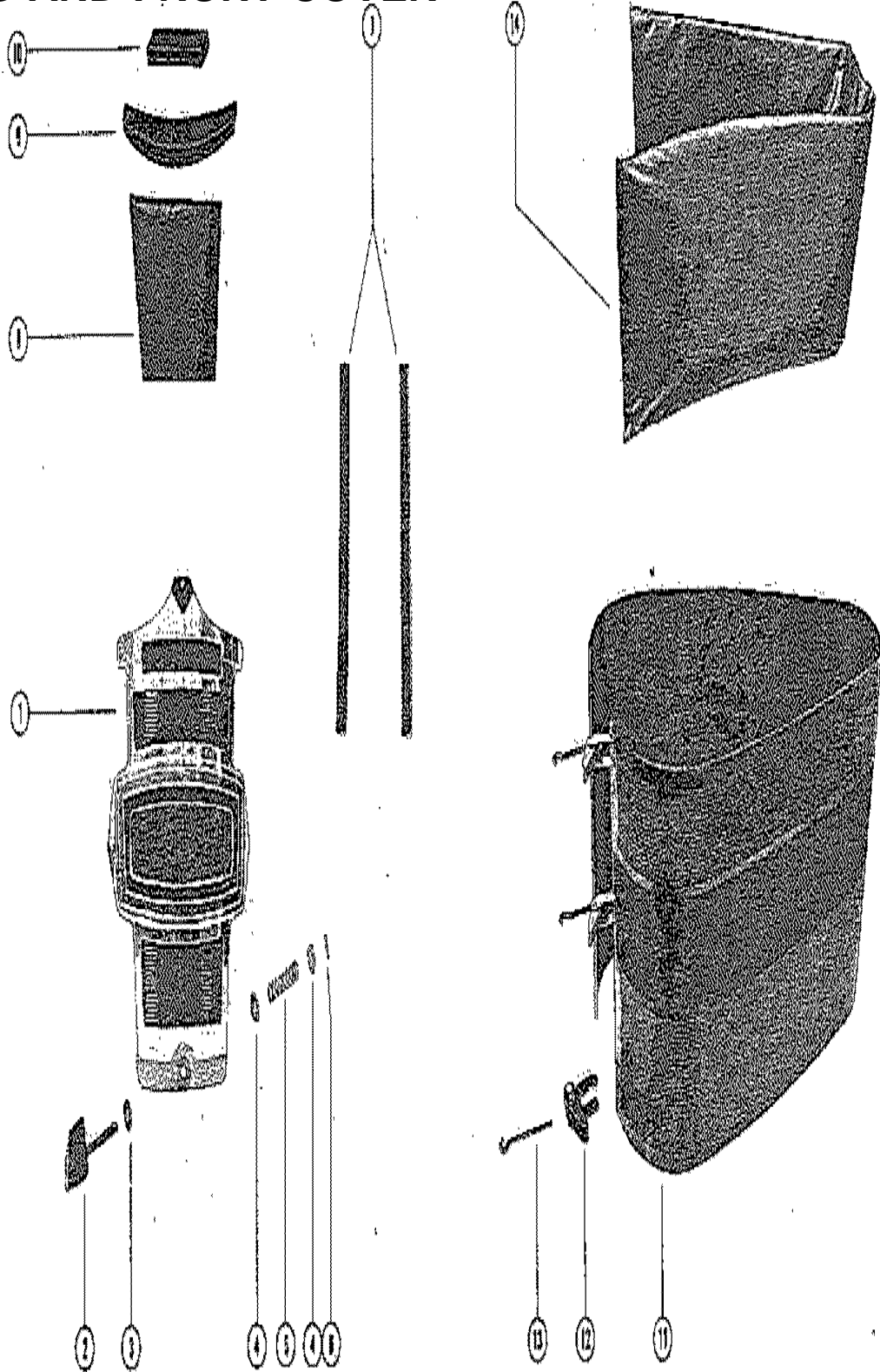

COWLING AND FRONT COVER

REF. NO.	PART NO.	SYM.	QTY.	DESCRIPTION
1	2113-5631A4		1	COWL FRONT COVER ASSEMBLY (WITHOUT DECALS)
2	56849		1	KNOB, COWL FRONT COVER FASTENING
3	12-30771		2	WASHER, COVER FASTENING KNOB (RUBBER)
4	12-59572		2	WASHER, COVER FASTENING KNOB (PLASTIC)
5	24-30772		1	SPRING, TENSION - FASTENING KNOB
6	17-29077		1	ROLL PIN, TENSION SPRING TO KNOB
7	31089		2	STRIP, SOUND ABSORBING
8	38674		1	BAG, STARTER ROPE
9	35769		1	SEAL, SOUND ABSORBING - UPPER
10	53334		1	SEAL, SOUND ABSORBING - TOP
11	2136-4660A4		1	WRAP AROUND COWL ASSEMBLY (WITHOUT DECALS)
12	46785A1		3	COWL LATCH ASSEMBLY
13	30413		3	HOOK, COWL LATCH FASTENING
14	30021		1	BLANKET, SOUND ABSORBING
-	92-25234--1		1	GLUE, ADHESIVE - BLANKET FASTENING
-	92-27109--1		1	ADHESIVE COMPOUND, EMBLEM FASTENING

FLYWHEEL, STARTER MOTOR AND STATOR

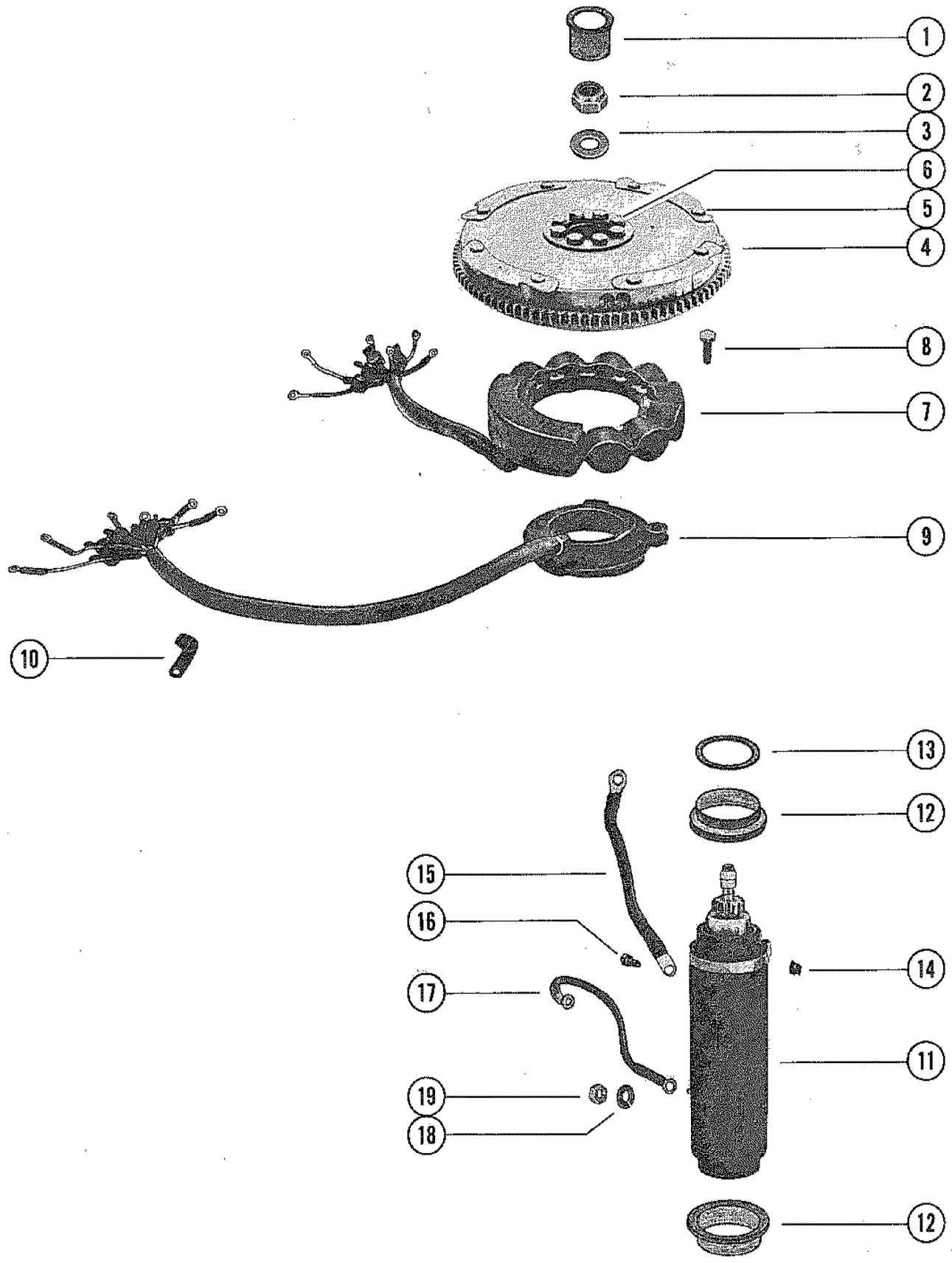

FLYWHEEL, STARTER MOTOR AND STATOR

REF. NO.	PART NO.	SYM.	QTY.	DESCRIPTION
1	19-45907		1	PLUG, FLYWHEEL
2	11-52901		1	NUT, FLYWHEEL ATTACHING
3	12-68229		1	WASHER, FLYWHEEL ATTACHING
4	248-5977A28		1	FLYWHEEL, ASSEMBLY, COMP.
5	10-32417		8	SCREW, FLYWHEEL PLATE
6	10-68997		8	SCREW, FLYWHEEL HUB
7	398-5454A8		1	STATOR ASSEMBLY
8	10-75840		4	SCREW, STATOR ATTACHING (7/8")
9	68162A8		1	TRIGGER PLATE ASSEMBLY
10	54-61001		3	CLAMP, TRIGGER HARNESS
11	50-72467		1	STARTER MOTOR
12	56703		2	COLLAR, STARTER MOTOR
13	23-56774		AR	SPACER, STARTER MOTOR
14	57247		2	STOP, RUBBER - STARTER MOTOR
15	84-66008A1		1	WIRE ASSEMBLY PLATE TO STARTER MOTOR (BLACK)
16	10-69035		1	SCREW, CABLE TO STARTER MOTOR
17	84-73453		1	WIRE ASSEMBLY SOLENOID TO STARTER MOTOR (YELLOW)
18	13-26992		1	LOCKWASHER, STARTER MOTOR TERMINAL
19	11-64015		1	NUT, STARTER MOTOR TERMINAL

THROTTLE LEVER AND LINK RODS

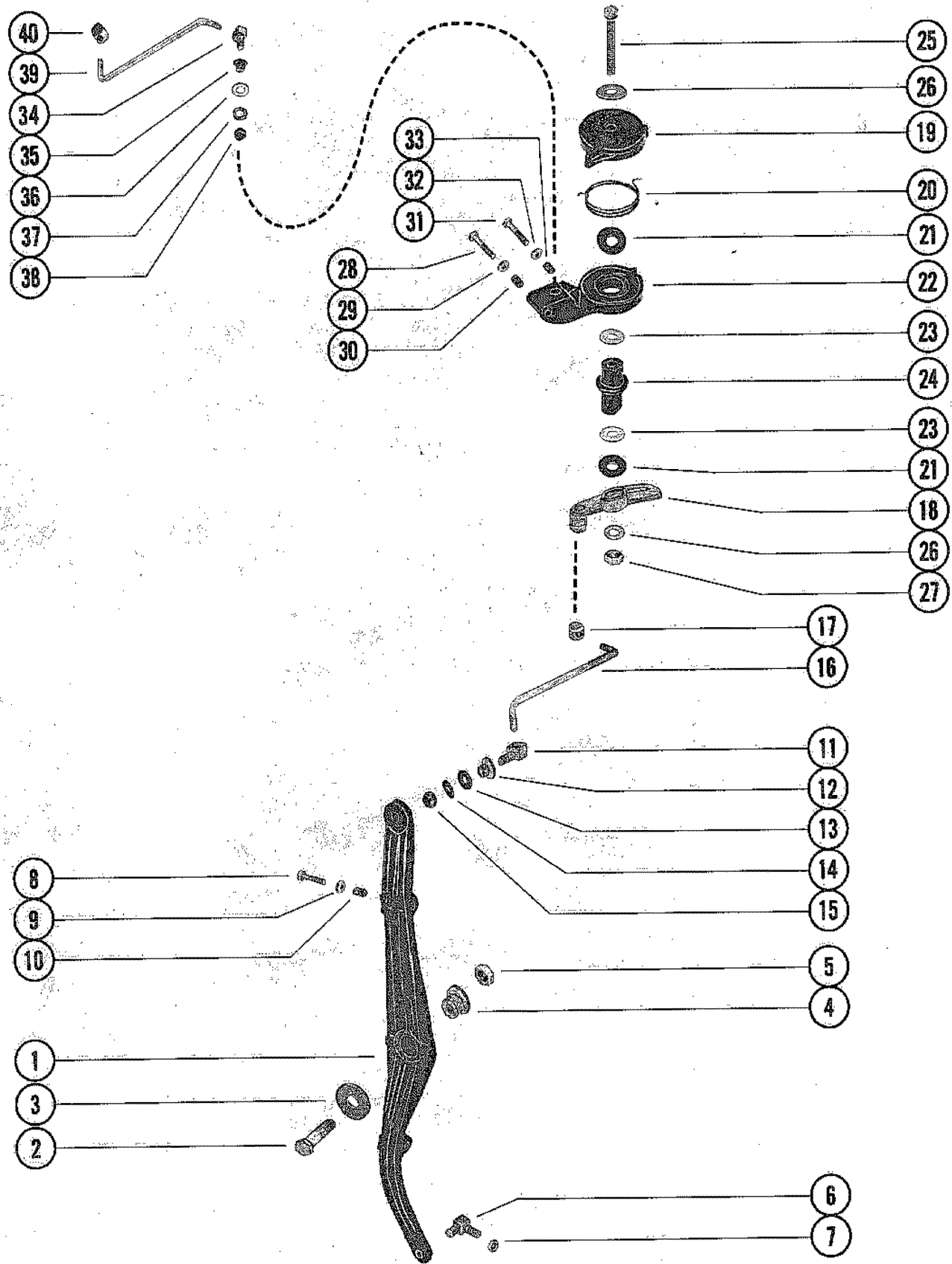

THROTTLE LEVER AND LINK RODS

REF. NO.	PART NO.	SYM.	QTY.	DESCRIPTION
1	79900		1	LEVER, THROTTLE
2	10-37559		1	SCREW, THROTTLE LEVER TO EXHAUST COVER
3	12-29395		1	WASHER, THROTTLE LEVER SCREW
4	23-45818		1	BUSHING, THROTTLE LEVER SCREW
5	11-20509		1	NUT, THROTTLE LEVER SCREW
6	37587		1	SWIVEL, THROTTLE LEVER TO THROTTLE CABLE
7	11-20509		1	NUT, THROTTLE CABLE TO SWIVEL
8	10-75168		2	SCREW, ADJUSTING - THROTTLE LEVER
9	11-29598		2	NUT, ADJUSTING SCREW
10	52023		2	CAP, NYLON - ADJUSTING SCREW
11	77013A1		1	SWIVEL ASSEMBLY, THROTTLE LEVER
12	23-26856		1	BUSHING, SWIVEL
13	12-33786		1	WASHER, SWIVEL
14	13-29402		1	WAVE WASHER, SWIVEL
15	11-45774		1	NUT, SWIVEL TO THROTTLE LEVER
16	85300		1	LINK ROD, THROTTLE
17	23-74213		1	SWIVEL, LINK ROD TO THROTTLE CAM
18	85441		1	THROTTLE CAM
19	85082		1	HOUSING, THROTTLE - UPPER
20	24-85442		1	SPRING, TORSION - SHAFT
21	12-85303		2	WASHER, PLASTIC - THROTTLE CAM
22	79903		1	HOUSING, THROTTLE - LOWER
23	13-86498		2	WAVE WASHER, SHAFT
24	87937		1	SHAFT, THROTTLE AND SPARK ADVANCE
25	10-28239		1	SCREW, THROTTLE HOUSING
26	12-35462		2	WASHER, THROTTLE HOUSING SCREW
27	11-72008		1	NUT, THROTTLE HOUSING SCREW
28	10-75168		1	SCREW, ADJUSTING - LOWER HOUSING (2 1/4")
29	11-29598		1	NUT, ADJUSTING SCREW
30	52023		1	CAP, NYLON - ADJUSTING SCREW
31	10-25158		1	SCREW, ADJUSTING - LOWER HOUSING (1 1/2")
32	11-68219		1	NUT, ADJUSTING SCREW
33	48039		1	CAP, NYLON - ADJUSTING SCREW
34	77013A1		1	SWIVEL ASSEMBLY, SPARK LINK
35	23-26856		1	BUSHING, SWIVEL
36	12-33786		1	WASHER, SWIVEL
37	13-29402		1	WAVE WASHER, SWIVEL
38	11-45774		1	NUT, SWIVEL
39	85301		1	SPARK LINK
40	74897		1	BARREL, SPARK LINK TO TRIGGER

WIRING HARNESS, SWITCH BOX AND IGNITION COIL

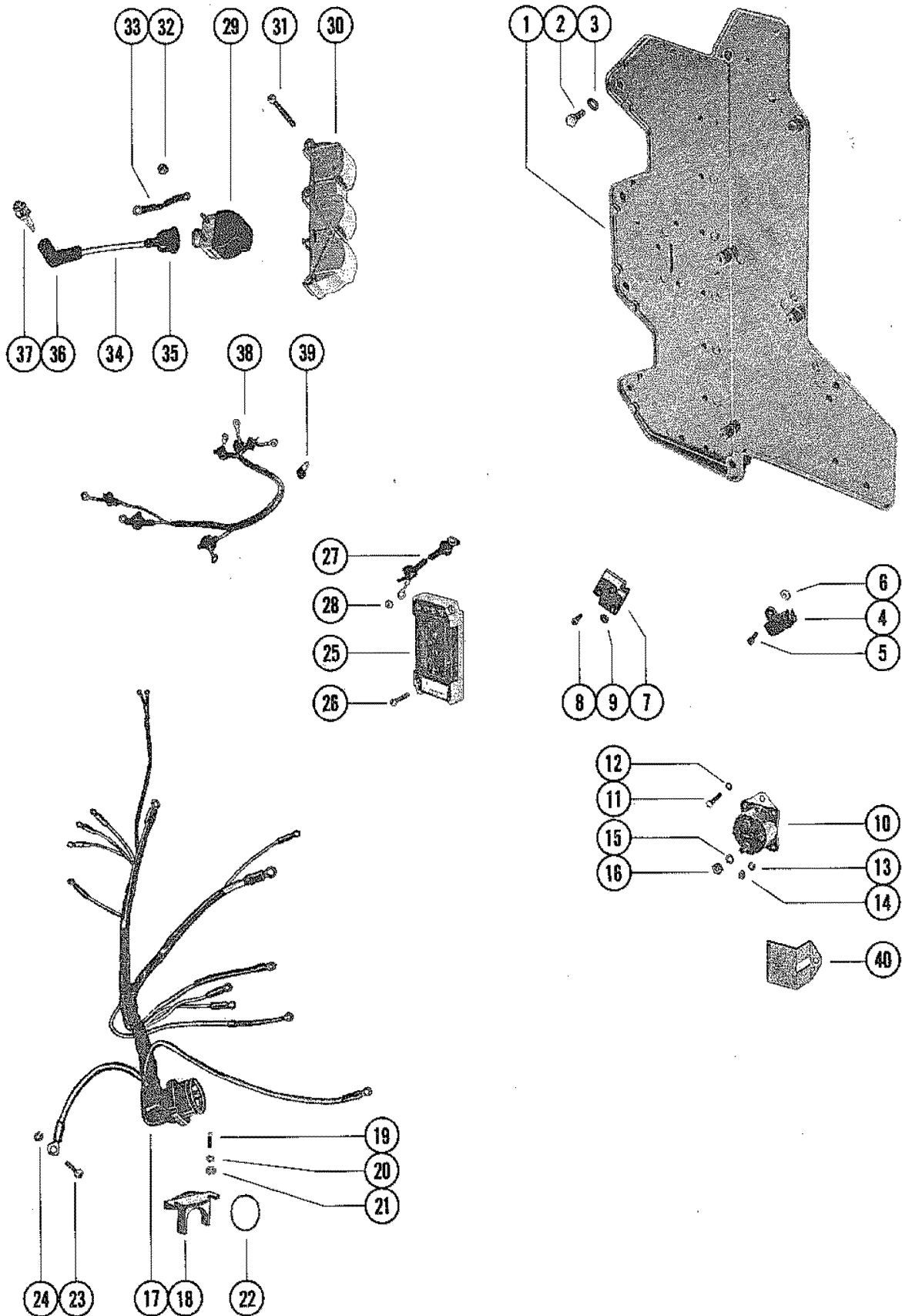

WIRING HARNESS, SWITCH BOX AND IGNITION COIL

REF. NO.	PART NO.	SYM.	QTY.	DESCRIPTION
1	79479		1	PLATE, ELECTRICAL MOUNTING
2	10-86885		4	SCREW, PLATE TO CYLINDER BLOCK (1 1/2")
	10-28636		2	SCREW, PLATE TO CYLINDER BLOCK (3/4")
	10-28667		3	SCREW, PLATE TO CYLINDER BLOCK (1")
3	12-38753		7	WASHER, PLATE SCREW
4	87-33386A2		1	SWITCH ASSEMBLY, MERCURY
5	10-25764		1	SCREW, MERCURY SWITCH TO PLATE (5/8")
6	11-45076		1	NUT, WIRE TO MERCURY SWITCH
7	62351A1		1	RECTIFIER ASSEMBLY
8	10-25764		2	SCREW, RECTIFIER TO IGNITION PLATE (5/8")
9	11-45076		3	NUT, RECTIFIER TERMINALS
10	89-76545		1	SOLENOID, STARTER
11	10-38601		2	SCREW, STARTER SOLENOID TO PLATE (1/2")
12	13-26992		2	LOCKWASHER, STARTER SOLENOID SCREW
13	13-26996		2	LOCKWASHER, SOLENOID TERMINALS (#10)
14	11-68219		2	NUT, SOLENOID TERMINALS (10-32)
15	13-26993		2	LOCKWASHER, SOLENOID TERMINALS (5/16")
16	11-68292		2	NUT, SOLENOID TERMINALS (5/16 - 18)
17	84-85532		1	WIRING HARNESS, INTERNAL
18	54-76368		1	CLAMP, WIRING HARNESS TO BOTTOM COWL
19	10-69020		2	SCREW WIRING HARNESS CLAMP TO BOTTOM COWL (7/8")
20	13-26996		2	LOCKWASHER, WIRING HARNESS CLAMP SCREW
21	12-30164		2	WASHER, WIRING HARNESS CLAMP SCREW
22	24-28975		1	SPRING, GARTER - INTERNAL WIRING HARNESS
23	10-69052		1	SCREW, GROUND WIRE TO BOTTOM COWL
24	13-26992		1	LOCKWASHER, GROUND WIRE SCREW
25	332-5524A1		2	SWITCH BOX ASSEMBLY
26	10-26251		4	SCREW, SWITCH BOX TO IGNITION COIL (7/8")
27	84-62310A3		1	CABLE ASS'Y SWITCH BOX TO SWITCH BOX (WHITE AND BLACK)
28	11-45076		20	NUT, SWITCH BOX TERMINAL
29	338-4995A2		6	COIL ASSEMBLY, IGNITION
30	73218		2	COVER, IGNITION COIL
31	10-69046		12	SCREW, IGNITION COIL COVER (2")
32	11-45076		12	NUT, IGNITION COIL TERMINAL
33	84-60466A1		6	CABLE ASSEMBLY, IGNITION COIL (BLACK)
34	84-73451A8		6	CABLE, HIGH TENSION
35	332-2854		6	BOOT, HIGH TENSION CABLE
36	85-71006A1		6	PROTECTOR, HIGH TENSION CABLE

CONTINUED ON NEXT PAGE ➡

WIRING HARNESS, SWITCH BOX AND IGNITION COIL

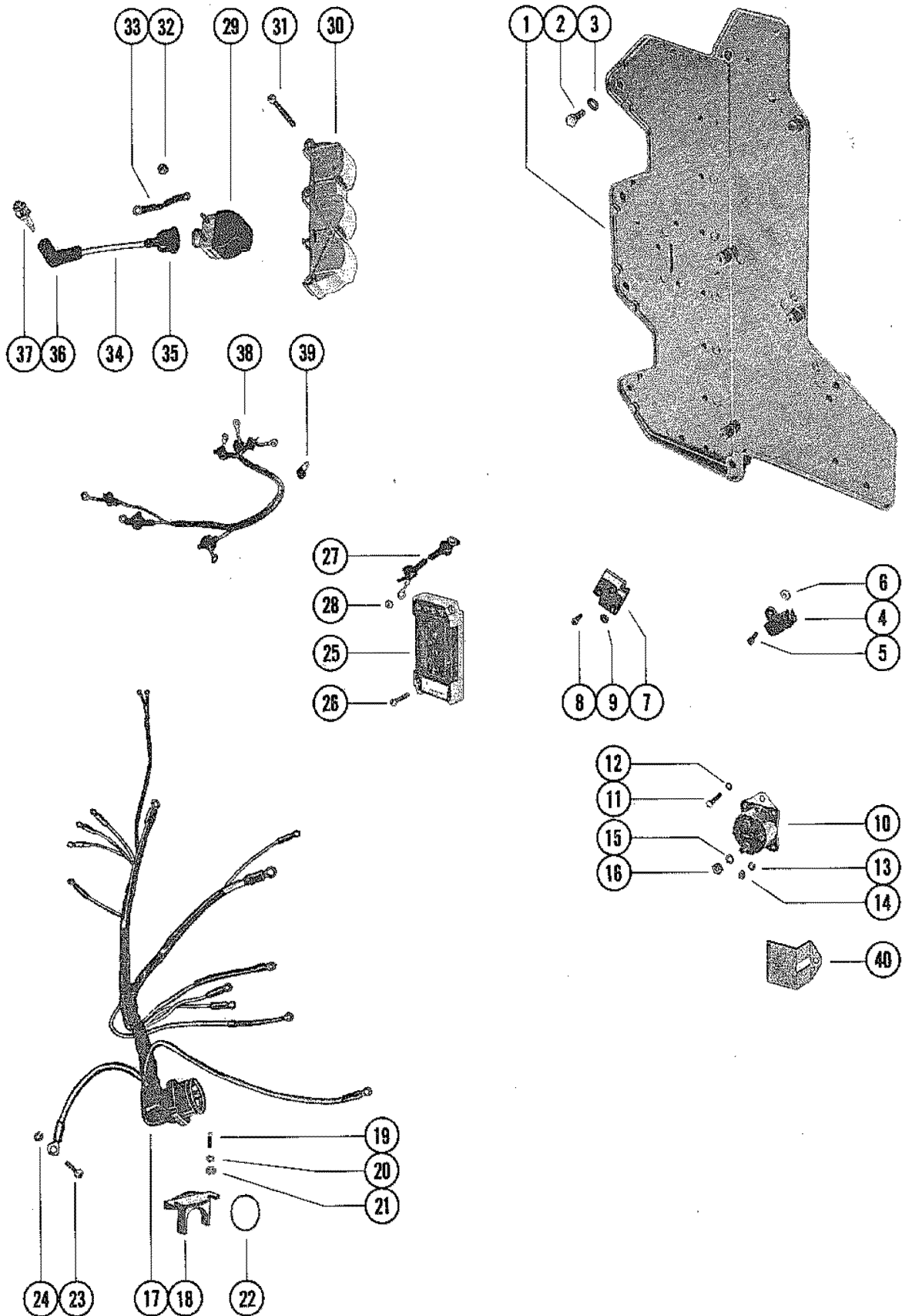

WIRING HARNESS, SWITCH BOX AND IGNITION COIL

REF. NO.	PART NO.	SYM.	QTY.	DESCRIPTION
37	33-68057		6	SPARK PLUG (CHAMPION #L76-V)
38	84-85537A2		1	HARNESS ASSEMBLY COIL TO SWITCH BOX (#2,4 AND 6)
	84-85537A1		1	HARNESS ASSEMBLY COIL TO SWITCH BOX (#1,3 AND 5)
39	54-63153		2	CLIP, HARNESS TO COIL COVER
40	85-78866		1	INSULATOR, STARTER SOLENOID

CARBURETOR LINKAGE AND CHOKE SOLENOID

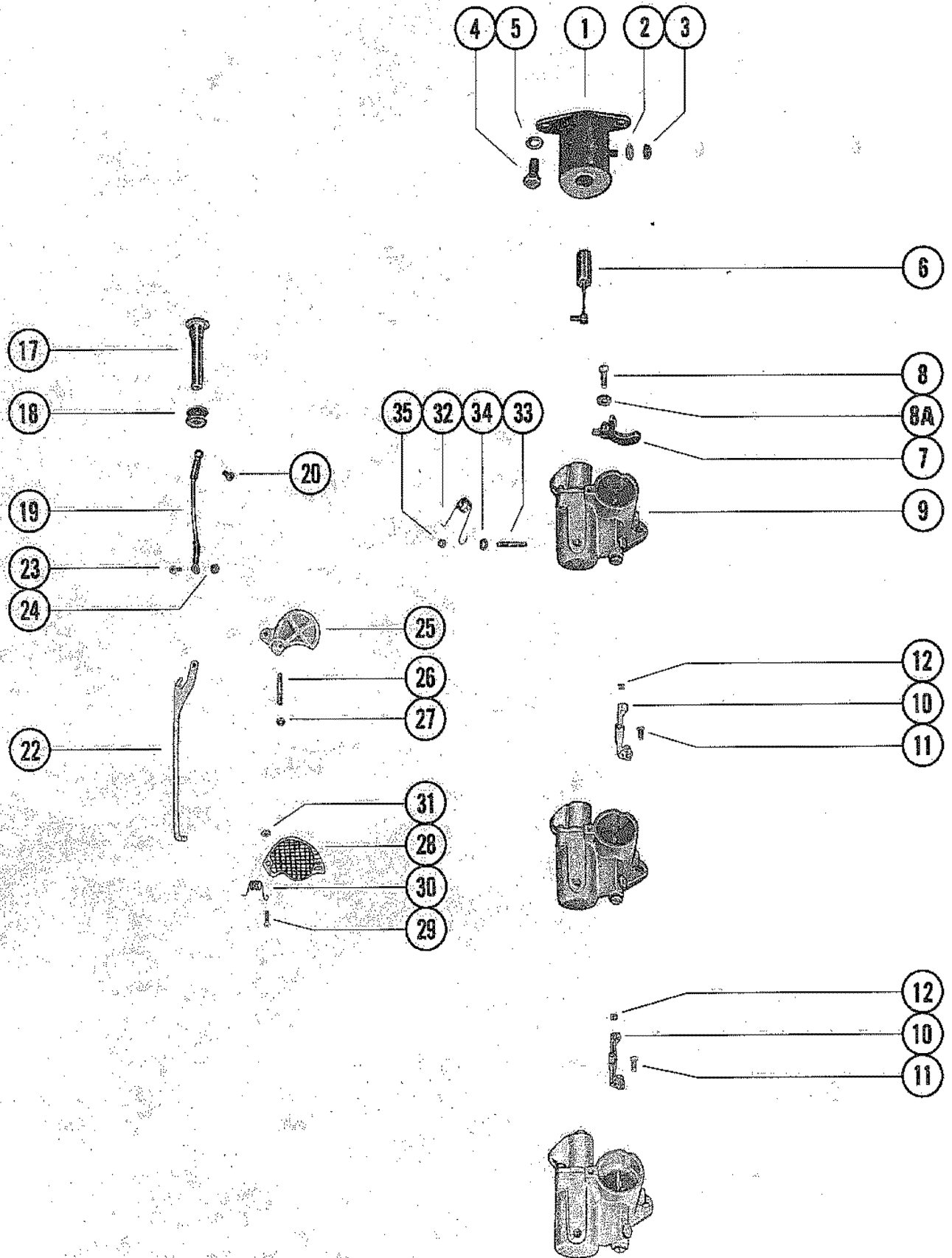

CARBURETOR LINKAGE AND CHOKE SOLENOID

REF. NO.	PART NO.	SYM.	QTY.	DESCRIPTION
1	54293A4		1	CHOKE SOLENOID
2	13-26996		1	LOCKWASHER, SOLENOID TERMINAL
3	11-68219		1	NUT, SOLENOID TERMINAL
4	10-25299		2	SCREW, CHOKE SOLENOID (3/4")
5	13-26993		2	LOCKWASHER, CHOKE SOLENOID SCREW
6	54283A1		1	PLUNGER AND LINK ASSEMBLY, CHOKE SOLENOID
7	85943A1		1	LEVER, THROTTLE (UPPER CARBURETOR)
8	10-60293		1	SCREW, THROTTLE LEVER
8A	12-74726		1	WASHER, THROTTLE LEVER SCREW
9	1368-7469A1		1	CARBURETOR ASSEMBLY (TOP)
	1368-7469A3		2	CARBURETOR ASSEMBLY (CENTER/BOTTOM)
10	53720A2		2	THROTTLE PICK-UP BRACKET ASSEMBLY
11	10-66104		2	SCREW, THROTTLE BRACKET MOUNTING
12	53665		2	INSERT, THROTTLE COUPLING
17	73755A1		1	KNOB, CHOKE ROD
18	25-20116		1	GROMMET, CHOKE ROD
19	49589		1	STRAP, CHOKE KNOB TO CHOKE ROD
20	10-76196		1	SCREW, STRAP TO CHOKE KNOB (5/8")
22	48203		1	ROD, CHOKE
23	10-48591		1	SCREW, STRAP TO CHOKE ROD (1/2")
24	11-46438		1	NUT, STRAP TO CHOKE ROD SCREW
25	48152		2	SHUTTER, CHOKE - CARBURETOR
26	16-69037		2	STUD, CARBURETOR - CHOKE SHUTTER PIVOT
27	11-20110		2	NUT, CHOKE SHUTTER TO CARBURETOR STUD
28	35-57819		3	SCREEN ASSEMBLY, FILTER - CARBURETOR
29	10-22523		1	SCREW LOWER CARBURETOR FILTER SCREEN TO CARB. (5/8")
	10-23015		2	SCREW UPPER CARBURETOR FILTER SCREEN TO CARB. (1")
30	24-57818		2	SPRING, UPPER FILTER SCREEN SCREW
31	11-20110		3	NUT CARBURETOR FILTER SCREEN FASTENING SCREW
32	24-48230		1	SPRING, CHOKE ROD TENSION
33	16-39937		1	STUD, CHOKE ROD SPRING TO CARBURETOR
34	23-32427		1	SPACER, CHOKE ROD SPRING STUD
35	11-46887		1	NUT, CHOKE ROD SPRING TO CARBURETOR STUD

CARBURETOR ASSEMBLY

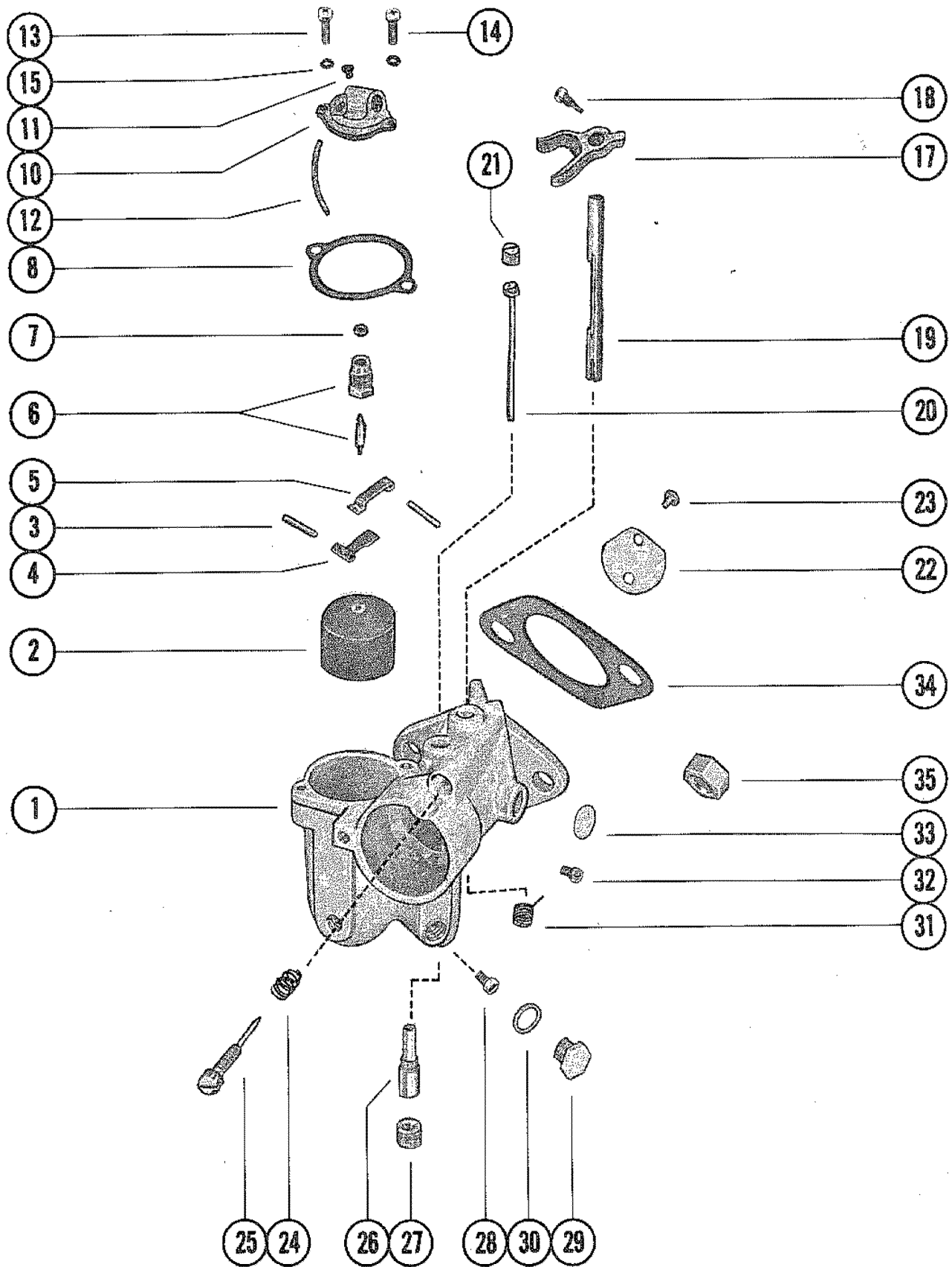

CARBURETOR ASSEMBLY

REF. NO.	PART NO.	SYM.	QTY.	DESCRIPTION
1	1368-7469A1		1	CARBURETOR ASSEMBLY (TOP)
	1368-7469A3		2	CARBURETOR ASSEMBLY (CENTER/BOTTOM)
2	1395-5353		3	FLOAT ASSEMBLY
3		■	6	PIN, FLOAT LEVER PINION
4		■	3	LEVER, FLOAT (LOWER)
5		■	3	LEVER, FLOAT (UPPER)
6	1395-4555		3	INLET NEEDLE, SEAT AND GASKET
7		■▲	3	GASKET, INLET SEAT
8		■▲	3	GASKET, FLOAT BOWL COVER
10	1395-5680		3	COVER, FLOAT BOWL
11	1395-5733		3	JET, BOWL VENT
12	5734-		3	HOSE, ECONOMIZER
13	10-52195		3	SCREW, FLOAT BOWL COVER
14	1395-4804		3	SCREW, FLOAT BOWL COVER
15	13-26995		6	LOCKWASHER, FLOAT BOWL COVER SCREW
17	1399-97		3	LEVER, THROTTLE USED ON CENTER AND LOWER CARBURETOR ONLY--REPLACED WITH A-85943A1 LEVER ON UPPER CARBURETOR
18	10-20847		3	SCREW, THROTTLE STOP LEVER
19	1395-7614	■	1	SHAFT, THROTTLE (TOP)
	1399-3527		2	SHAFT, THROTTLE (CENTER/BOTTOM)
20		■	3	TUBE, IDLE
21	1395-4540		3	SCREW, BODY (IDLE TUBE)
22	1395-5108		3	SHUTTER, THROTTLE
23		■	6	SCREW AND LOCKWASHER, THROTTLE SHUTTER
24		■	3	SPRING, IDLE ADJUSTMENT SCREW
25		■	3	SCREW, IDLE ADJUSTMENT
26		■	3	NOZZLE, MAIN
27	1395-4542		3	SCREW, PLUG - MAIN NOZZLE
28	1399-3794		OPT	JET, MAIN FUEL (.074)
	1395-6207		OPT	JET, MAIN FUEL (.072)
	1395-6030	■	3	JET, MAIN FUEL (.070) - STANDARD
	1395-6029		OPT	JET, MAIN FUEL (.068)
29	1395-4541		3	SCREW, PLUG - MAIN FUEL JET CHANNEL
30		■▲	3	GASKET, JET CHANNEL PLUG SCREW
31		■	3	SPRING, THROTTLE SHAFT RETURN
32	1395-4543		3	SCREW, BODY CHANNEL
33		■	3	WELCH PLUG, BODY CHANNEL

- = CONTENTS OF C-[27-85653A79] GASKET SET
- = CONTENTS OF REPAIR PARTS KIT
- ▲ = CONTENTS OF GASKET AND PACKING SET

CONTINUED ON NEXT PAGE ➡

CARBURETOR ASSEMBLY

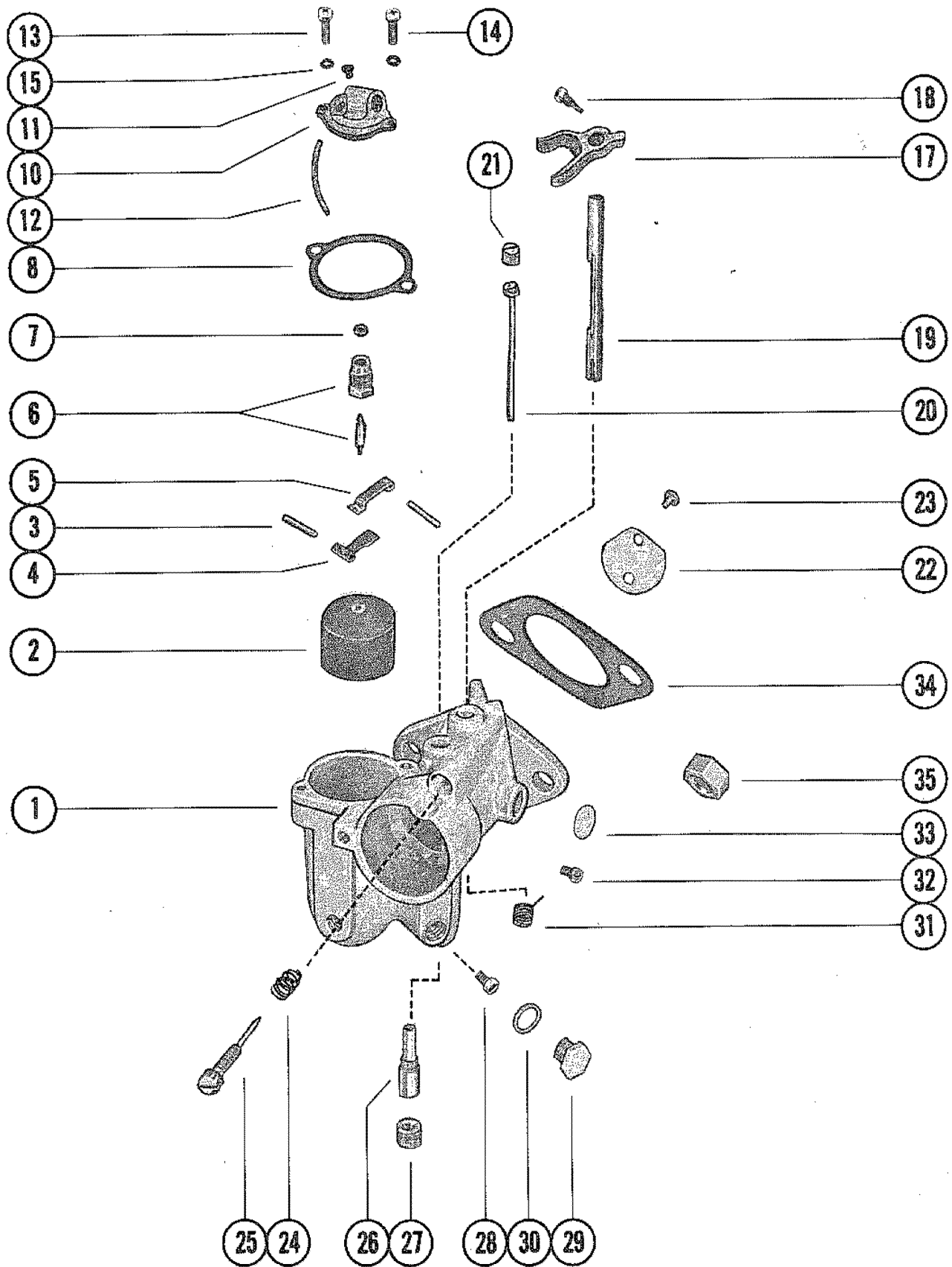

CARBURETOR ASSEMBLY

REF. NO.	PART NO.	SYM.	QTY.	DESCRIPTION
-	1395-4808	I	3	GASKET AND PACKING SET (1 PER CARBURETOR)
-	1395-7628		3	REPAIR PARTS KITS (1 PER CARBURETOR)
34	27-48164	● I ▲	3	GASKET, CARBURETOR FLANGE
35	11-64809		6	NUT, CARBURETOR MOUNTING STUD
-	27-85653A79		0	GASKET SET

USED ON CENTER AND LOWER CARBURETOR ONLY--REPLACED WITH A-[85943A1] LEVER ON UPPER CARBURETOR FOR PLASTIC VENTURI ORDER A-[52106A1]

- = CONTENTS OF C-[27-85653A79] GASKET SET
- I = CONTENTS OF REPAIR PARTS KIT
- ▲ = CONTENTS OF GASKET AND PACKING SET

FUEL PUMP AND FUEL LINE ASSEMBLY

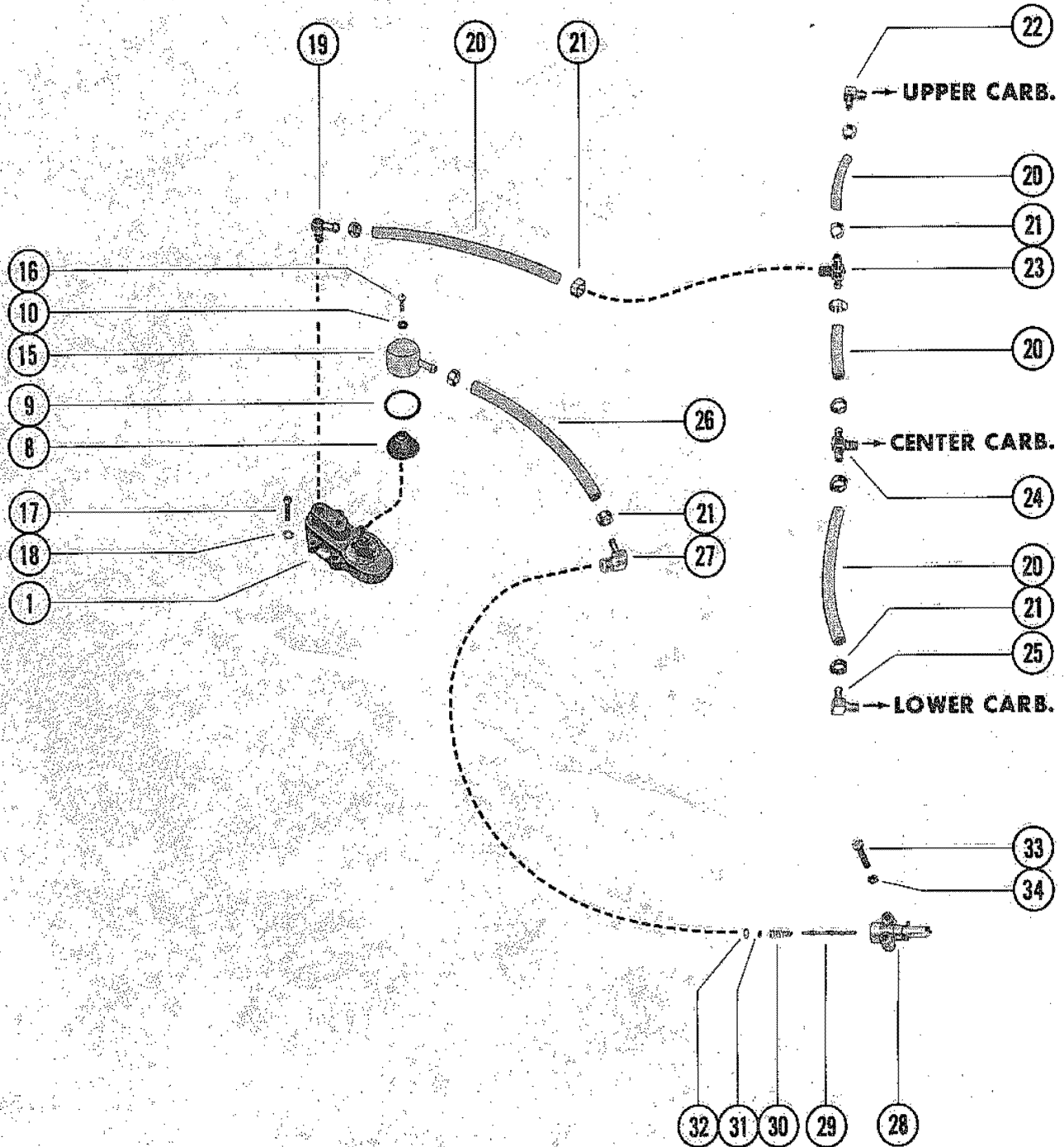
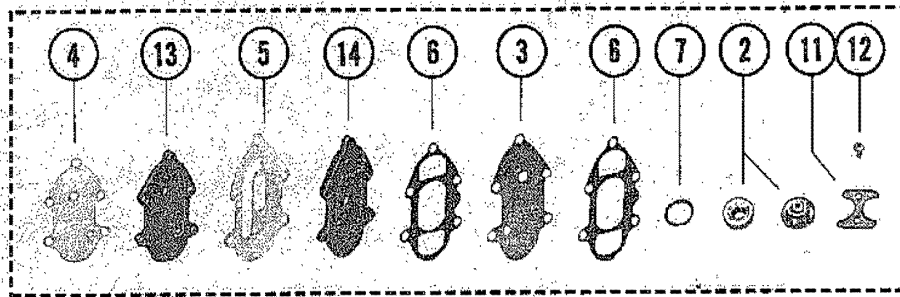

FUEL PUMP AND FUEL LINE ASSEMBLY

REF. NO.	PART NO.	SYM.	QTY.	DESCRIPTION
1	66530A6		1	FUEL PUMP ASSEMBLY
2	21-30430A10		1	CHECK VALVE ASSEMBLY
3	66599A3	●	1	DIAPHRAGM ASSEMBLY
4		●	1	GASKET, FUEL PUMP
5		●	1	GASKET, PULSE CHAMBER
6		●	2	GASKET, FUEL PUMP
7		●	2	GASKET, CHECK VALVE TO HOUSING
8	35-59072	●	1	SCREEN, FUEL INLET
9		●	1	"O" RING, FUEL INLET COVER
10		●	1	GASKET, COVER ATTACHING SCREW
11	23004		1	RETAINER, CHECK VALVE
12	10-20037		2	SCREW, RETAINER ATTACHING
13	86295		1	BASE, FUEL PUMP
14	87990		1	CHAMBER, PULSE - FUEL PUMP
15	59071		1	COVER, FUEL INLET
16	10-37370		1	SCREW, FUEL FILTER COVER ATTACHING (5/8")
17	10-73013		5	SCREW, FUEL PUMP ATTACHING (1 1/2")
18	13-26996		5	LOCKWASHER, FUL PUMP ATTACHING SCREW
19	22-64704		1	FITTING, FUEL OUTLET
20	32-70432		4	FUEL LINE FUEL PUMP TO CARBURETOR (6 1/4" - 2 3/4")
21	54-68424		10	CLAMP, FUEL LINE ATTACHING
22	22-64704		1	FITTING, ELBOW - UPPER CARBURETOR
23	22-73318		1	TEE, FUEL LINE
24	22-64706		1	FITTING, TEE - CENTER CARBURETOR
25	22-64704		1	FITTING, ELBOW - LOWER CARBURETOR
26	32-70432		1	FUEL LINE, ADAPTOR TO FUEL PUMP (16")
27	22-63981		1	ELBOW, FUEL LINE TO ADAPTOR
28	22833		1	ADAPTOR, CHECK UNIT (FUEL LINE)
29	23069		1	STEM, CHECK UNIT ADAPTOR
30	24-23067		1	SPRING, ADAPTOR STEM
31	25-20415	●	1	"O" RING, ADAPTOR STEM
32	30188		1	CUP WASHER, ADAPTOR
33	10-69029		2	SCREW, ADAPTOR TO BOTTOM COWL (1 3/4")
34	11-36069		2	NUT, ADAPTOR SCREW
-	27-85653A79		0	GASKET SET

● = CONTENTS OF C-[27-85653A79] GASKET SET

CYLINDER BLOCK AND CRANKCASE ASSEMBLY

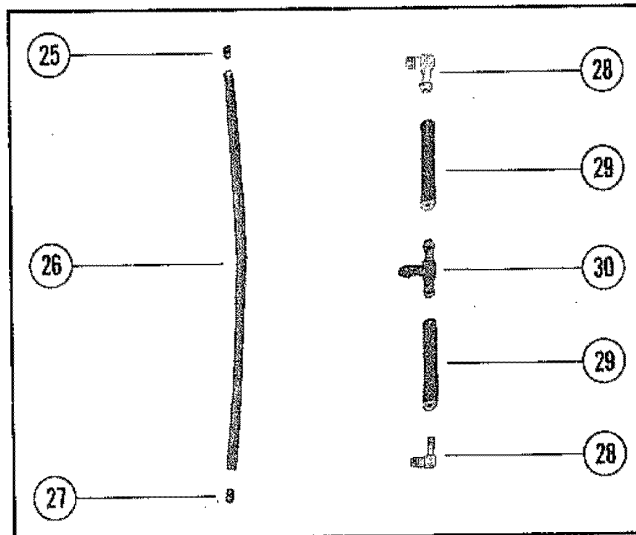
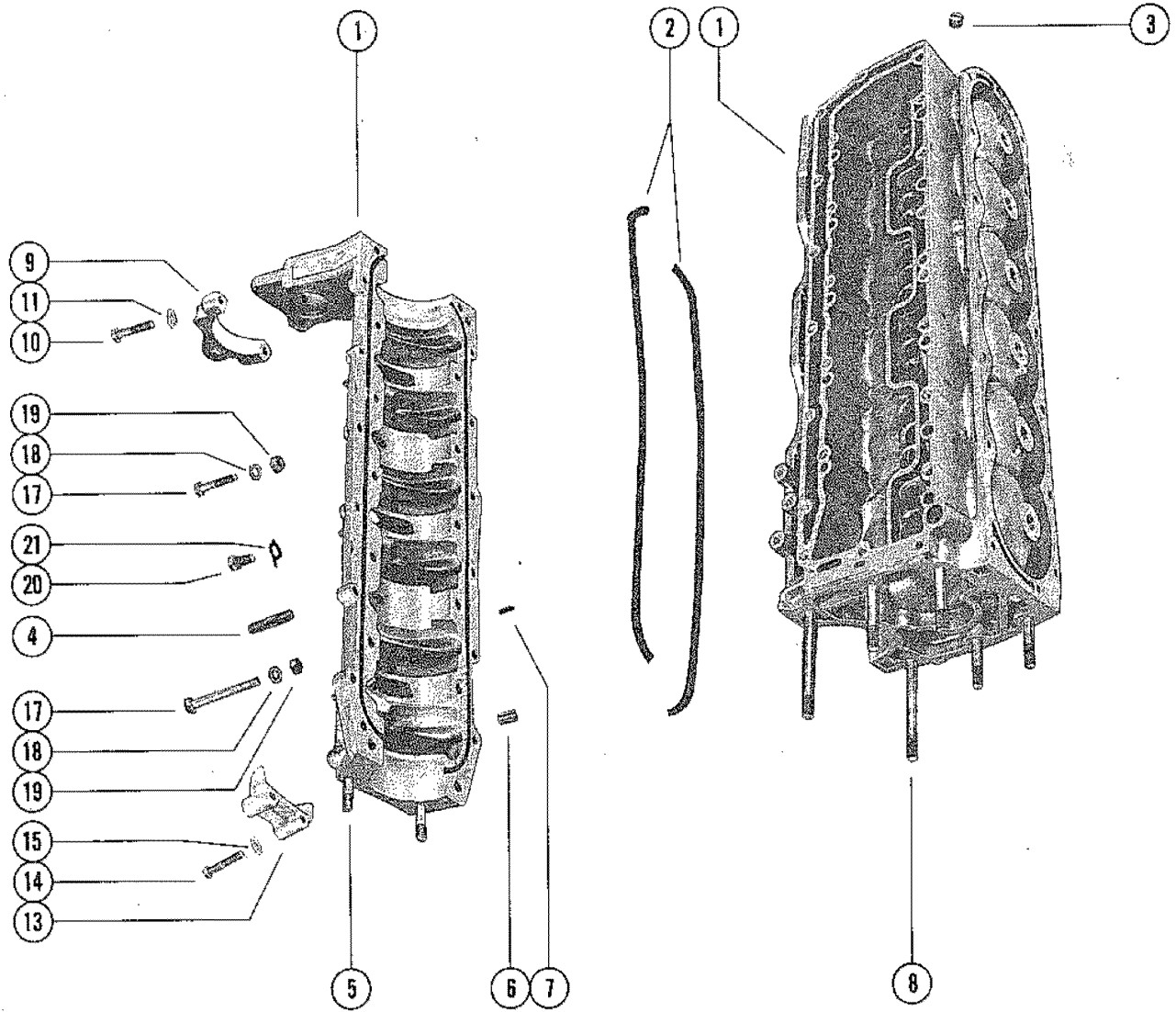

CYLINDER BLOCK AND CRANKCASE ASSEMBLY

REF. NO.	PART NO.	SYM.	QTY.	DESCRIPTION
1	852-7741A2		1	CYLINDER BLOCK AND CRANKCASE ASSEMBLY
2	27-53862	●	2	GASKET, CRANKCASE TO CYLINDER BLOCK
3	66517		5	RESTRICTION, CRANKCASE BLEED
4	16-64280		6	STUD, CARBURETOR MOUNTING (1 3/16")
5	16-64281		2	STUD CRANKCASE TO EXHAUST EXTENSION PLATE (1 7/8")
6	17-20033		2	PIN, DOWEL - CRANKCASE TO CYLINDER BLOCK
7	17-63779		3	PIN, DOWEL - CYLINDER BLOCK TO MAIN BEARING
8	16-64282		6	STUD CYLINDER BLOCK TO DRIVE SHAFT HOUSING PLATE (4")
9	86473		1	COVER, STARTER MOTOR BRACKET - TOP
10	10-77065		2	SCREW, TOP COVER ATTACHING (2")
11	13-26993		2	LOCKWASHER, TOP COVER SCREWS
13	76867		1	COVER, STARTER MOTOR BRACKET - BOTTOM
14	10-69268		2	SCREW, BOTTOM COVER ATTACHING (1 7/8")
15	13-26993		2	LOCKWASHER, BOTTOM COVER SCREW
17	10-57841		3	SCREW, CRANKCASE TO CYLINDER BLOCK (2 3/4")
	10-32293		3	SCREW, CRANKCASE TO CYLINDER BLOCK (1 3/4")
	10-73657		20	SCREW, CRANKCASE TO CYLINDER BLOCK (1 1/2")
	10-53016		2	SCREW, CRANKCASE TO CYLINDER BLOCK (1 1/4")
18	12-22753		25	WASHER CRANKCASE TO CYLINDER BLOCK SCREWS
19	11-29250		2	NUT CRANKCASE TO CYLINDER BLOCK SCREWS (LOWER)
20	10-20359		2	SCREW, CENTER MAIN BEARING LOCKING
21	14-20091		2	TAB WASHER, BEARING LOCKING SCREW
25	21-77560		1	CHECK VALVE, BLEED HOSE - UPPER
26	32-54936		1	HOSE, BLEED (22")
27	21-77561		1	CHECK VALVE, BLEED HOSE - LOWER
28	22-25885		2	ELBOW, BALANCE HOSE
29	32-34395A1		2	HOSE, BALANCE - MAIN BEARING (6 1/4")
30	22-85578		1	TEE, BALANCE HOSE
-	27-85653A79		0	GASKET SET

FOR REPLACEMENT OF POWERHEAD ASSEMBLY, COMPLETE, WHICH INCLUDES CYLINDER BLOCK AND CRANKCASE, PISTONS, CONNECTING RODS, AND BEARINGS, ETC. ORDER: A-[789811A79] POWERHEAD ASSEMBLY
 ● = CONTENTS OF C-[27-85653A79] GASKET SET

END CAP, MANIFOLD AND EXHAUST COVERS

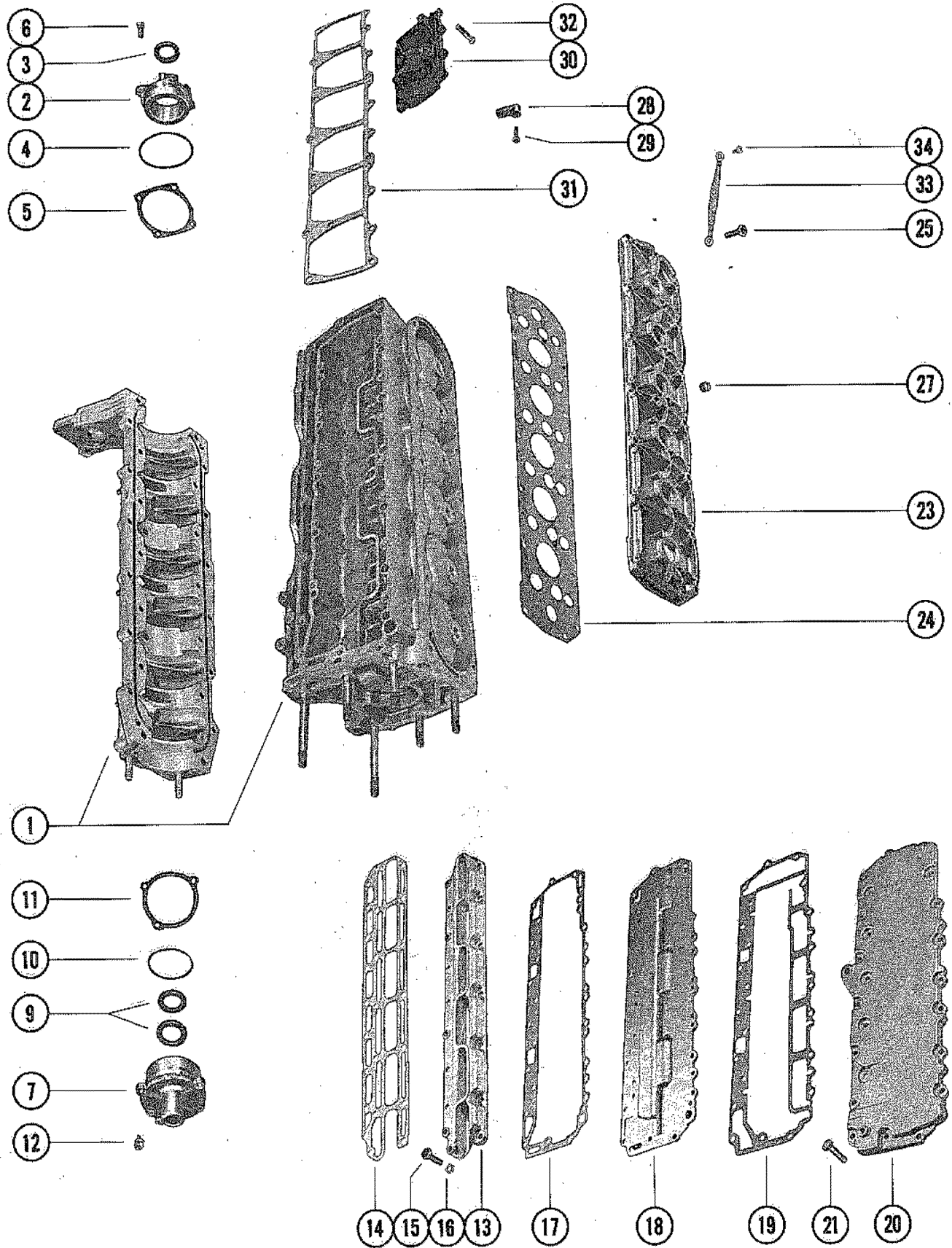

END CAP, MANIFOLD AND EXHAUST COVERS

REF. NO.	PART NO.	SYM.	QTY.	DESCRIPTION
1	852-7741A2		1	CYLINDER BLOCK AND CRANKCASE ASSEMBLY
2	1161-5940A2		1	END CAP ASSEMBLY
3	26-29476		1	OIL SEAL, END CAP
4	25-47254	●	1	"O" RING
5	15-73644A1		AR	SHIM, END CAP TO CRANKCASE (.006-10)
6	10-73169		4	SCREW, END CAP MOUNTING (1")
7	1148-5410A1		1	END CAP ASSEMBLY, LOWER
9	26-29476		2	OIL SEAL, END CAP
10	25-32546	●	1	"O" RING, END CAP
11	15-20085A1		AR	SHIM, END CAP TO CRANKCASE (.005-10)
12	10-69034		3	SCREW, END CAP MOUNTING (1")
13	71808		1	COVER, WATER JACKET - CYLINDER BLOCK
14	27-72142	●	1	GASKET, WATER JACKET COVER
15	10-53167		23	SCREW WATER JACKET COVER TO CYLINDER BLOCK (7/8")
16	12-70132		23	WASHER WATER JACKET COVER FASTENING SCREW
17	27-72507	●	1	GASKET, CYLINDER BLOCK TO BAFFLE PLATE
18	75778		1	PLATE, BAFFLE - EXHAUST MANIFOLD
19	27-72509	●	1	GASKET BAFFLE PLATE TO EXHAUST MANIFOLD COVER
20	86316		1	COVER, EXHAUST MANIFOLD
21	10-53576		24	SCREW, MANIFOLD COVER MOUNTING
23	1023-5070		1	COVER, CYLINDER BLOCK
24	27-72506	●	1	GASKET, CYLINDER BLOCK COVER
25	10-69100		16	SCREW, COVER MOUNTING (1")
27	22-68307		1	PLUG, PIPE - CYLINDER BLOCK COVER
28	37440		1	BRACKET, MOUNT SUPPORT - CYLINDER BLOCK
29	10-24234		1	SCREW, BRACKET TO CYLINDER BLOCK (1")
30	87872		3	COVER, TRANSFER PORT
31	27-85653	●	1	GASKET, TRANSFER PORT COVER
32	10-28636		24	SCREW TRANSFER PORT COVER MOUNTING (3/4")
33	46933A3		2	GROUND STRAP ASSEMBLY CYLINDER BLOCK COVER
34	10-62568		2	SCREW, GROUND STRAP ATTACHING (3/8")
-	27-85653A79		0	GASKET SET

● = CONTENTS OF C-[27-85653A79] GASKET SET

CRANKSHAFT, PISTONS AND CONNECTING RODS

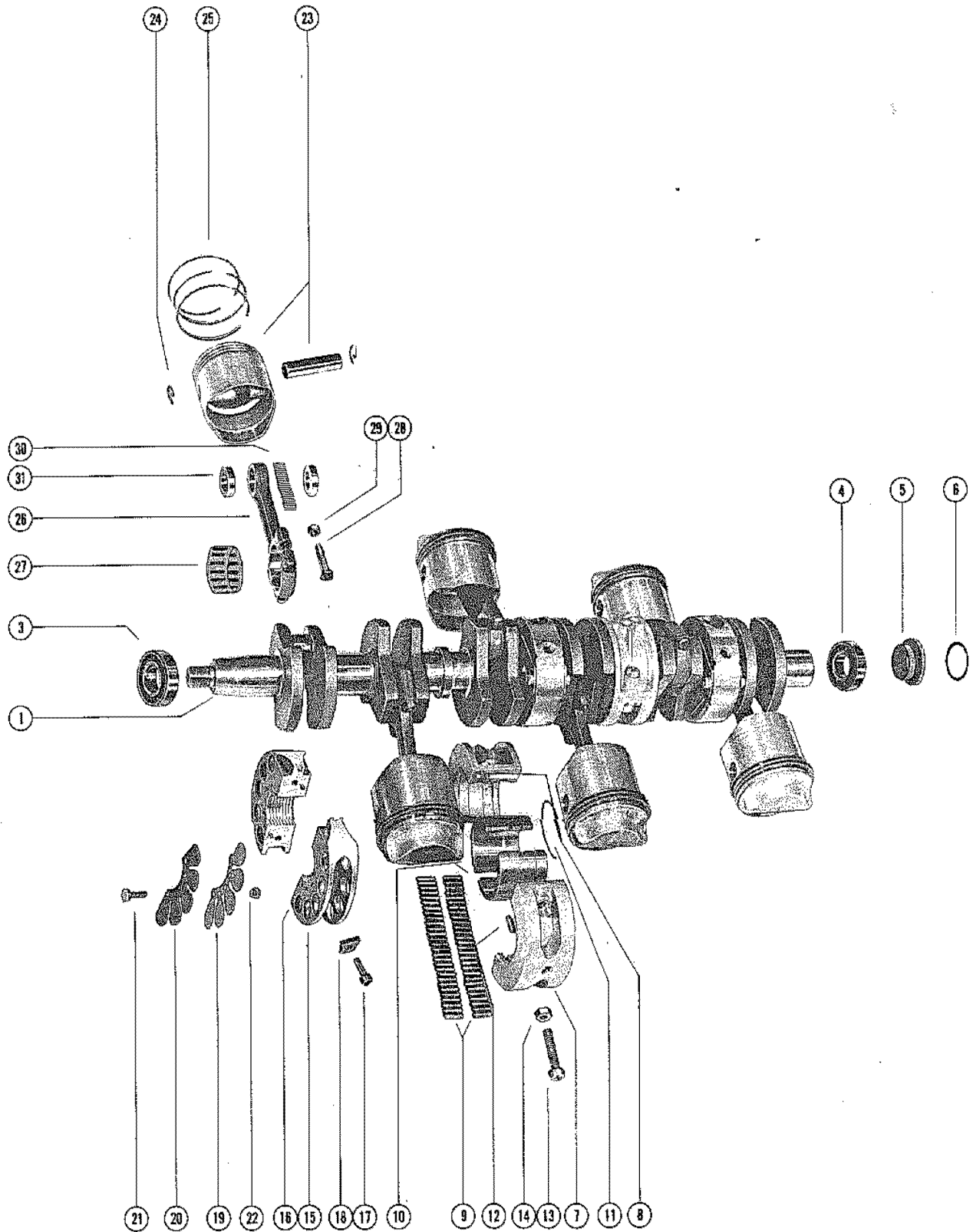

CRANKSHAFT, PISTONS AND CONNECTING RODS

REF. NO.	PART NO.	SYM.	QTY.	DESCRIPTION
1	436-6646A2		1	CRANKSHAFT ASSEMBLY
3	30-62567		1	BEARING, BALL - UPPER
4	30-63742		1	BEARING, BALL -LOWER
5	54196A6		1	CARRIER ASSEMBLY, "O" RING
6	65800	●	1	"O"RING, CARRIER
7	535-5397A4		2	CENTER MAIN BEARING ASSEMBLY
8	17-20032		4	DOWEL PIN, CENTER MAIN BEARING
9	29-52168		112	BEARING, NEEDLE - OUTER RACE
10	26113		2	RACE, OUTER (PAIR)
11	53-26933		2	RING, SNAP - OUTER RACE
12	17-47246		2	DOWEL PIN, STEPPED
13	10-22968		4	SCREW, CENTER MAIN BEARING CLAMPING
14	11-46887		4	NUT, BEARING CLAMPING SCREW
15	540-5266A5		3	MAIN BEARING ASSEMBLY, VALVE TYPE
16	17-20032		6	DOWEL PIN, MAIN BEARING
17	10-45775		6	SCREW, MAIN BEARING CLAMPING
18	11-45774		6	NUT, MAIN BEARING CLAMPING SCREW
19	34-56007A1		3	REED SET, MATCHED - MAIN BEARING
20	34-56008		12	REED STOP, MAIN BEARING REED VALVES
21	10-62204		30	SCREW, REED STOP MOUNTING
22	11-53153		30	NUT, REED STOP SCREW
23	745-6661A4		6	PISTON AND PISTON PIN ASSEMBLY
24	40-52035		12	LOCK RING, PISTON PIN
25	39-78816A12		2	RING, PISTON
26	622-4850A3		6	CONNECTING ROD AND CAP ASSEMBLY
27	31-62596A1		6	BEARING ASSEMBLY, CRANKPIN
28	10-54803		12	SCREW, CONNECTING ROD
29	11-49091		12	NUT, CONNECTING ROD SCREWS
30	29-47270		174	BEARING, NEEDLE - PISTON PIN
31	12-47247		12	WASHER, NEEDLE LOCATING
-	745-6696A2		6	PISTON AND PISTON PIN ASSEMBLY .015 OVERSIZE PISTONS AND RINGS
-	39-78811A12		2	RING, PISTON .015 OVERSIZE PISTONS AND RINGS
-	27-85653A79		0	GASKET SET

● = CONTENTS OF C-[27-85653A79] GASKET SET

BOTTOM COWL AND SHIFT LINKAGE

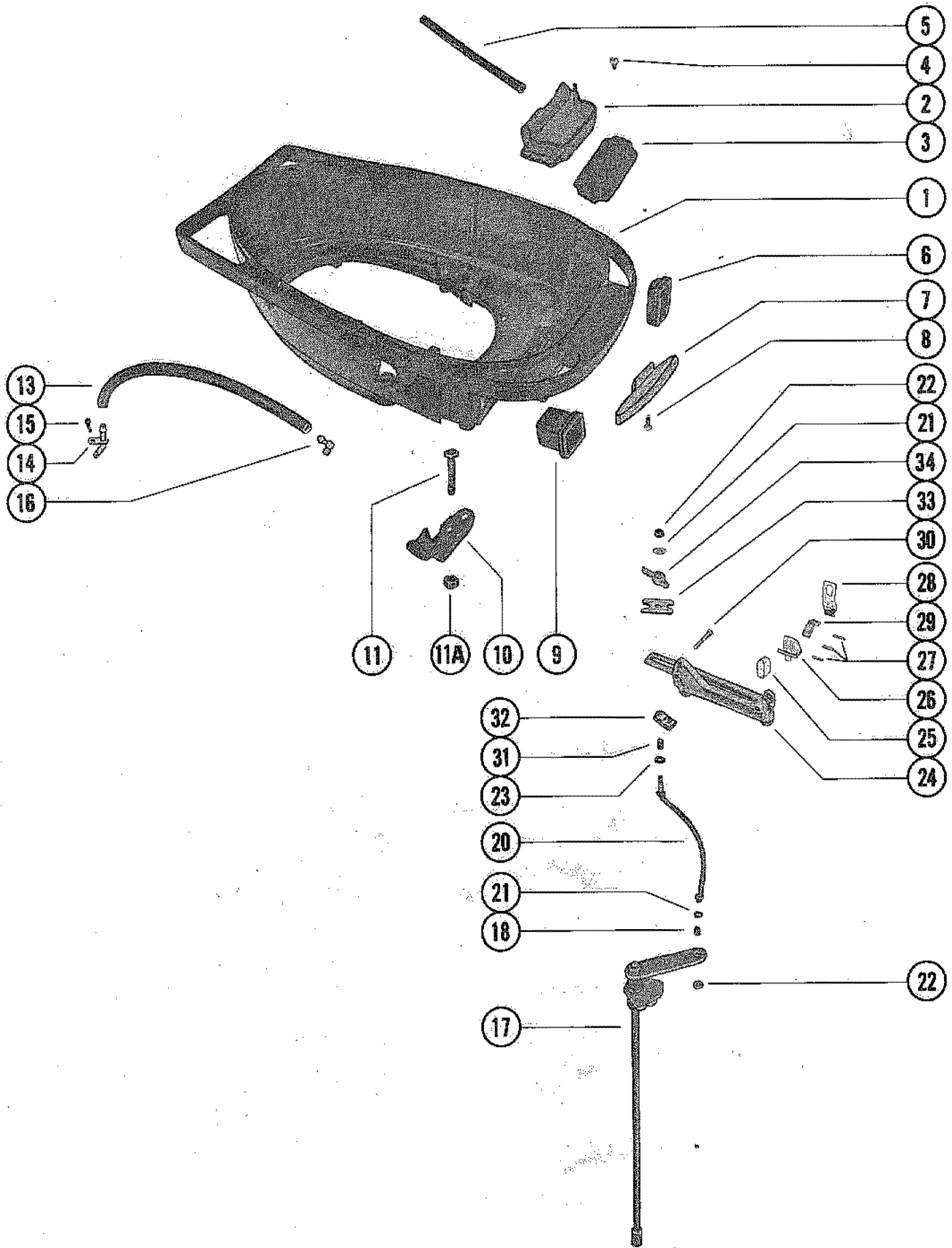

BOTTOM COWL AND SHIFT LINKAGE

REF. NO.	PART NO.	SYM.	QTY.	DESCRIPTION
1	2115-6462		1	COWL, BOTTOM
2	52862A2		1	DRIP TRAY ASSEMBLY, BOTTOM COWL
3	37940		1	PAD, SOUND - DRIP TRAY
4	10-48408		4	SCREW, DRIP TRAY TO BOTTOM COWL (1/2")
5	32-34395A1		1	HOSE, DRIP TRAY TO BOTTOM COWL (8")
6	39616		1	BOOT, CONTROL CABLES - BOTTOM COWL
7	76369		1	SPACER, BOTTOM COWL (COWL FRONT COVER)
8	10-48591		2	SCREW, SPACER TO BOTTOM COWL (1/2")
9	37637		1	BOOT, FUEL CONNECTOR - BOTTOM COWL
10	37445		1	SUPPORT, WIRING HARNESS - BOTTOM COWL
11	10-69029		2	SCREW, SUPPORT TO BOTTOM COWL (1 3/4")
11A	11-36069		2	NUT, SUPPORT SCREW
13	32-34395A1		1	HOSE TELL TALE - EXHAUST COVER TO BOTTOM COWL (21 1/2")
14	52889		1	NOZZLE, TELL TALE HOSE TO BOTTOM COWL
15	10-48408		1	SCREW TELL TALE NOZZLE TO BOTTOM COWL (1/2")
16	22-78279		1	ELBOW, TELL TALE HOSE TO CYLINDER BLOCK
17	60304A54		1	SHIFT SHAFT ASSEMBLY, UPPER
18	23-26600		1	BUSHING, SHIFT SHAFT
20	48047A1		1	LINK ROD ASSEMBLY
21	12-35462		2	WASHER, LINK ROD
22	11-20664		2	NUT, LINK ROD
23	13-29720		1	WASHER, WAVE - LINK ROD
24	52732		1	BRACKET, ANCHOR - CONTROL CABLES
25	39519		1	CAP, BARREL RETAINER - ANCHOR BRACKET
26	39618		1	LEVER, NYLON - SHIFT CABLE LOCKING
27	17-47175		3	PIN, LOCKING LEVER AND COVER FASTENING
28	39667		1	COVER, NYLON - SHIFT CABLE
29	65799		1	LINK, LOCKING LEVER TO COVER
30	10-24234		3	SCREW ANCHOR BRACKET TO CYLINDER BLOCK (1")
31	24-20099		1	SPRING, LINK ROD TO GUIDE BLOCK
32	3786		1	GUIDE BLOCK, LINK ROD
33	52100		1	WEAR PLATE, LINK ROD
34	38279		1	LATCH CONTROL CABLE FASTENING - ANCHOR BRACKET

EXHAUST EXTENSION PLATE

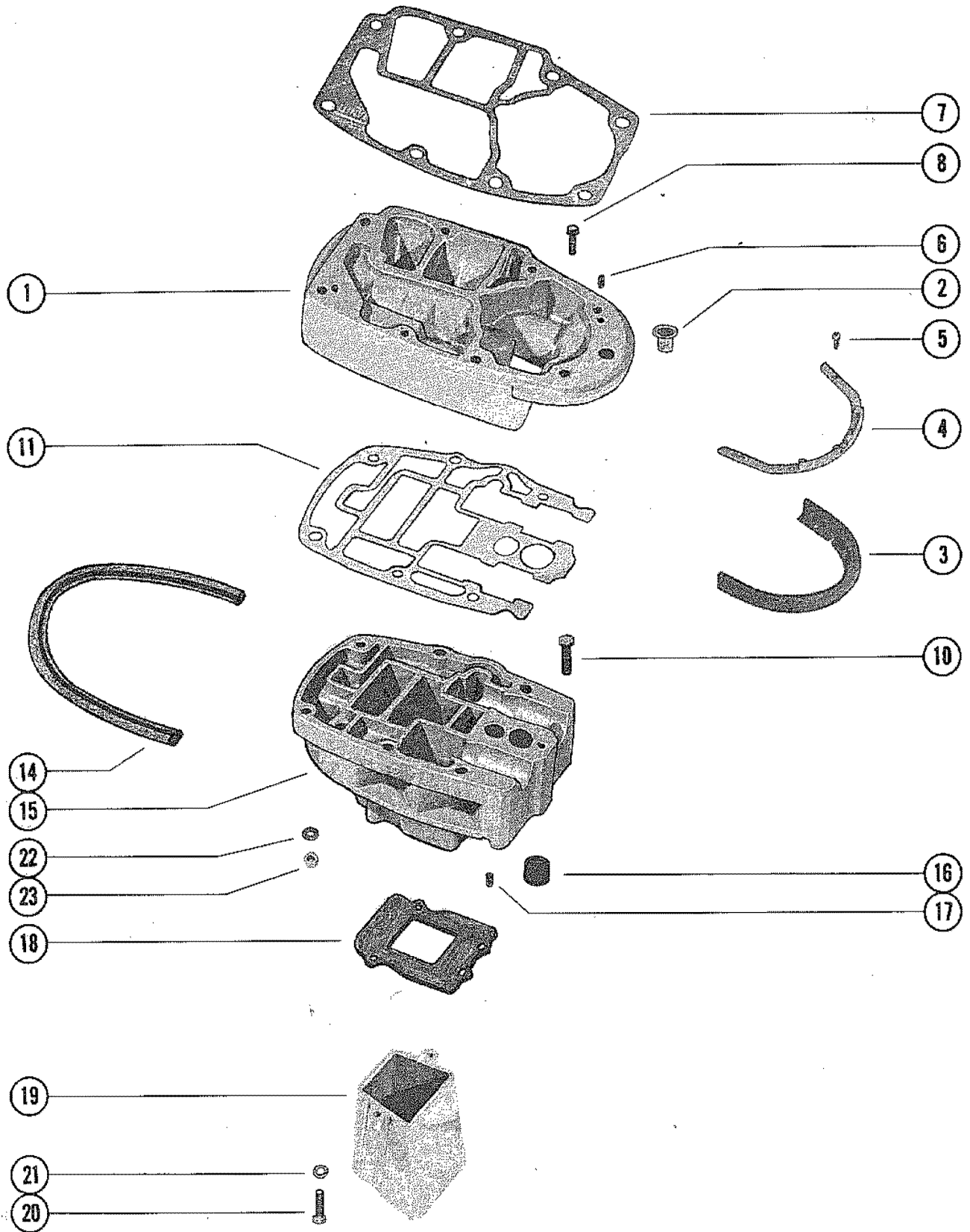

EXHAUST EXTENSION PLATE

REF. NO.	PART NO.	SYM.	QTY.	DESCRIPTION
1	66096A1		1	PLATE ASSEMBLY, EXHAUST EXTENSION
2	23-27132		1	BUSHING, NYLON - EXHAUST EXTENSION PLATE
3	37918		1	SEAL, EXHAUST EXTENSION PLATE
4	38032		1	STRIP, RETAINING EXHAUST EXTENSION PLATE SEAL
5	10-37571		5	SCREW SEAL AND RETAINING STRIP TO EXT. PLATE (1/2")
6	17-23784		2	DOWEL PIN, EXHAUST EXTENSION PLATE
7	27-69238	●	1	GASKET, POWERHEAD TO EXTENSION PLATE
8	10-66023		2	SCREW, ADAPTOR PLATE TO HOUSING PLATE (2")
10	10-66023		7	SCREW, HOUSING PLATE TO DRIVE SHAFT HGS. (2")
11	27-66102	●	1	GASKET, PLATE TO DRIVE SHAFT HSG. PLATE
14	26-60898		1	SEAL, DRIVE SHAFT HOUSING PLATE
15	74257A3		1	PLATE ASSEMBLY, DRIVE SHAFT HOUSING
16	26-38970	●	1	SEAL, RUBBER - WATER INLET TUBE
17	17-23784		2	DOWL PIN, DRIVE SHAFT HOUSING PLATE
18	27-62362	●	1	GASKET MEGAPHONE TO DRIVE SHAFT HOUSING PLATE
19	60437		1	MEGAPHONE, EXHAUST
20	10-60480		3	SCREW MEGAPHONE TO DRIVE SHAFT HOUSING PLATE (1 1/8")
21	12-29245		3	WASHER, MEGAPHONE SCREW
22	12-25970		6	WASHER, POWERHEAD STUD
23	11-34932		6	NUT, POWERHEAD STUD
-	27-85653A79		0	GASKET SET

● = CONTENTS OF C-[27-85653A79] GASKET SET

SWIVEL BRACKET ASSEMBLY

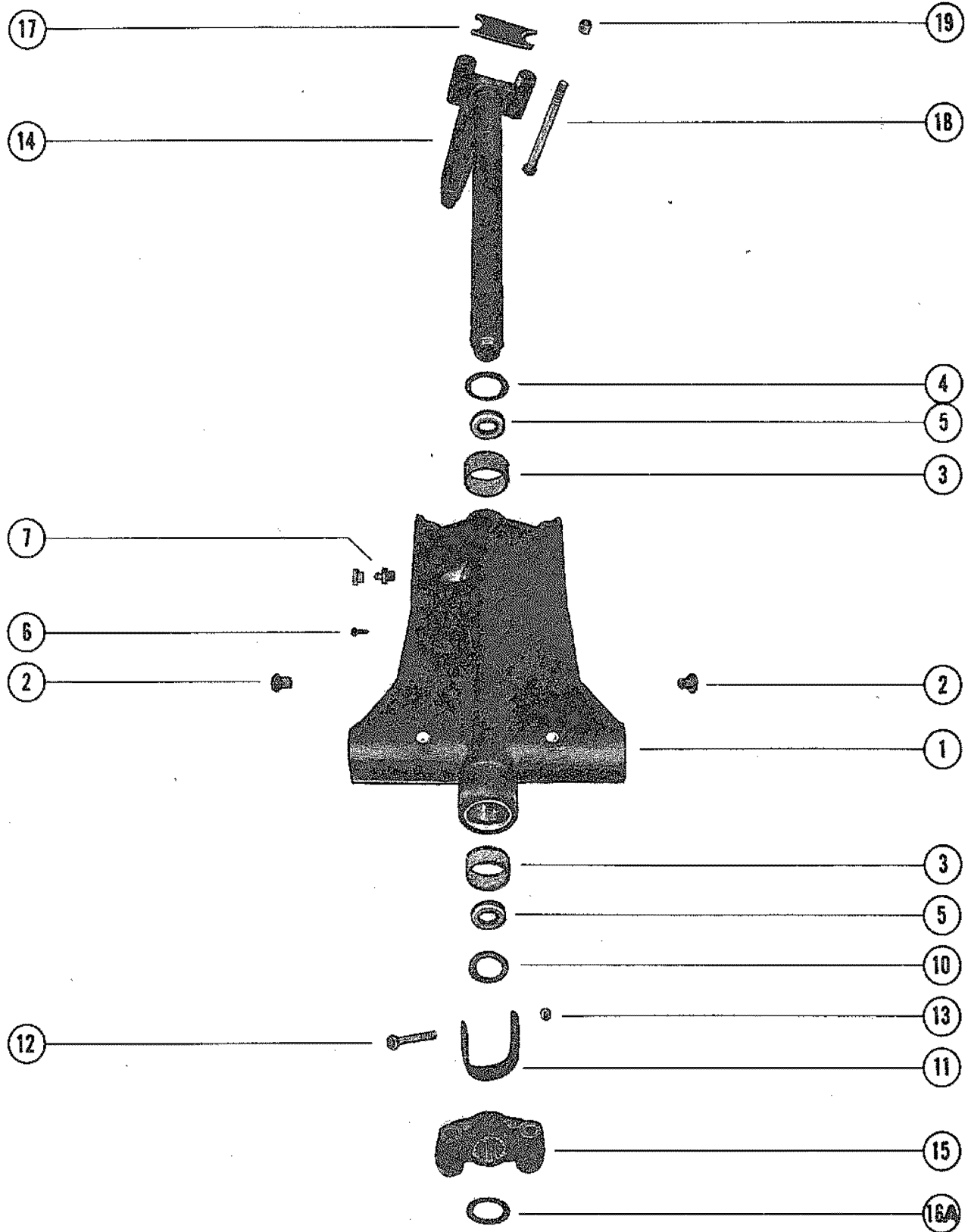

SWIVEL BRACKET ASSEMBLY

REF. NO.	PART NO.	SYM.	QTY.	DESCRIPTION
1	1482-6386A4		1	SWIVEL BRACKET ASSEMBLY
2	23-69132		2	BUSHING, REVERSE LOCK PIVOT SHAFT
3	23-69341		2	BUSHING, SWIVEL BRACKET
4	12-69342		1	WASHER, SWIVEL PIN - UPPER
5	26-37448		2	OIL SEAL, SWIVEL BRACKET
6	10-47828		1	SCREW, DRIVE - SWIVEL BRACKET
7	22-74036		4	FITTING, GREASE - SWIVEL BRACKET
10	12-69380		1	WASHER, SWIVEL PIN - LOWER
11	28205		1	STRAP STOP DRIVE SHAFT HOUSING TO SWIVEL BRACKET
12	10-28200		1	SCREW STRAP STOP TO DRIVE SHAFT HOUSING (2 7/8")
13	11-25269		1	NUT, STRAP STOP FASTENING SCREW
14	17-73593A1		1	SWIVEL PIN AND ARM ASSEMBLY
15	73984		1	YOKE, BOTTOM
16A	53-73591		1	RETAINING RING, BOTTOM YOKE ATTACHING
17	28203		1	BUMPER, STEERING ARM
18	10-49554		2	BOLT, STEERING ARM TO UPPER MOUNT (5 7/8")
19	11-34933		2	NUT, STEERING ARM BOLT FASTENING

CLAMP BRACKET AND REVERSE LOCK

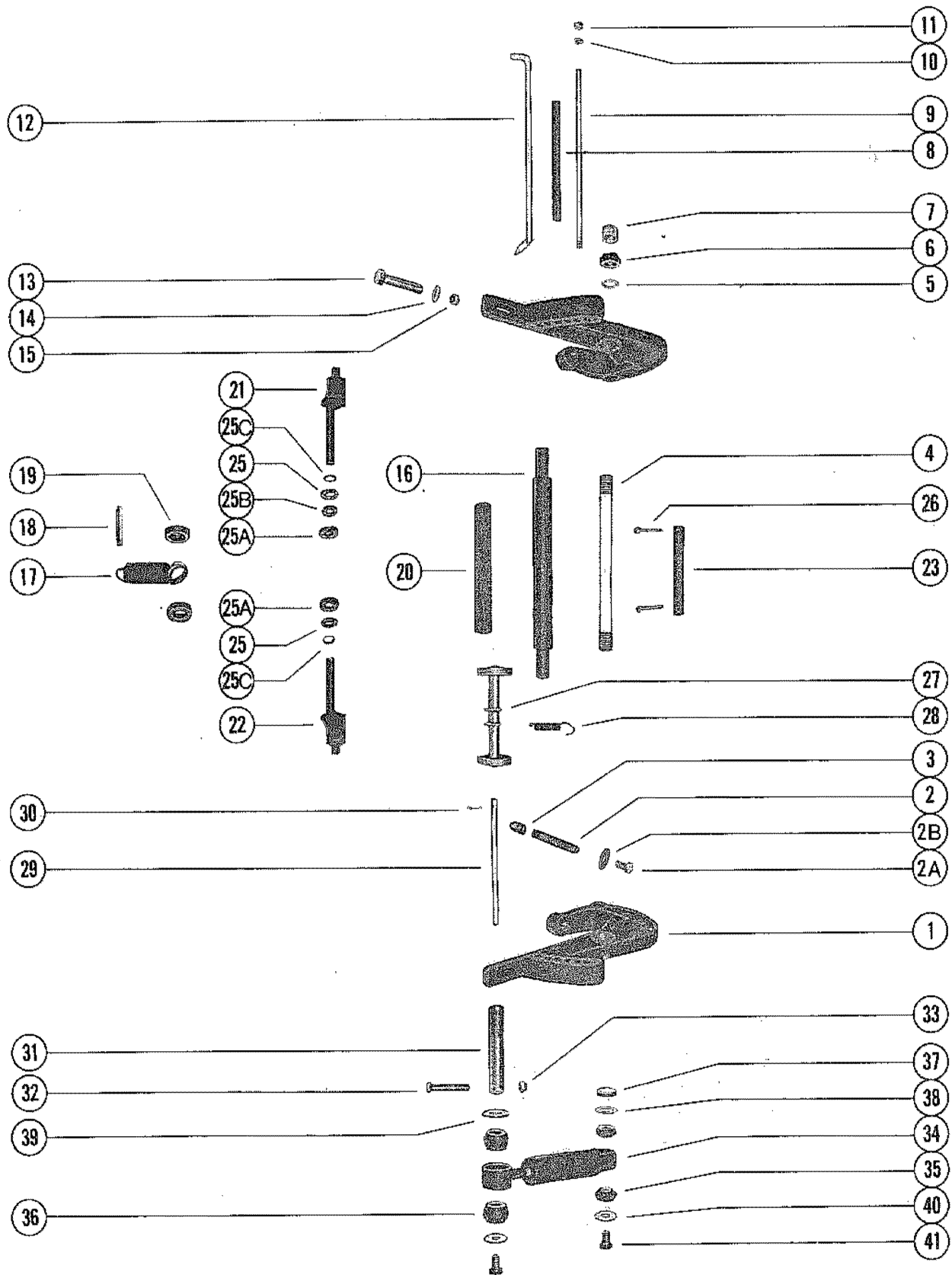

CLAMP BRACKET AND REVERSE LOCK

REF. NO.	PART NO.	SYM.	QTY.	DESCRIPTION
1	1440-6625A3		2	CLAMP BRACKET ASSEMBLY
2	10-78492A1		2	THUMB SCREW ASSEMBLY
2A	10-78495		2	SCREW, WASHER ATTACHING
2B	12-78493		2	WASHER, THUMB SCREW
3	75043		2	CAP, THUMB SCREW
4	74528		1	TUBE, TILT - CLAMP BRACKET TO SWIVEL BRACKET
5	12-52864		2	WASHER, CLAMP BRACKET TILT TUBE
6	11-56041		2	NUT, TILT TUBE FASTENING
7	53078		2	CAP, PLASTIC - TILT TUBE
8	23-59624		1	SPACER, CLAMP BRACKET STUD
9	16-59625		1	STUD, CLAMP BRACKET (NOT USED WITH FULL POWER TRIM)
10	13-26993		2	LOCKWASHER, CLAMP BRACKET STUD
11	11-28770		2	NUT, CLAMP BRACKET STUD
12	17-49930A1		1	TILT LOCK PIN ASSEMBLY (NOT USED WITH FULL POWER TRIM)
13	10-68298		2	BOLT CLAMP BRACKET TO BOAT TRANSOM (LOWER)
	10-68299		2	BOLT CLAMP BRACKET TO BOAT TRANSOM (UPPER)
14	12-68410		2	WASHER, CLAMP BRACKET BOLT (LOWER)
	12-68300		2	WASHER, CLAMP BRACKET BOLT (UPPER)
15	11-68411		4	NUT, CLAMP BRACKET BOLT
16	55-28416		1	PIN, UPPER SHOCK MOUNTING
17	24-28659		1	SPRING, COIL - SWIVEL BRACKET NOT USED WITH FULL POWER TRIM
18	17-38311		1	PIN, COIL SPRING MOUNTING NOT USED WITH FULL POWER TRIM
19	23-28688		2	SPACER, RUBBER - COIL SPRING POSITING NOT USED WITH FULL POWER TRIM
20	63473		1	TUBE CUSHION - SHOCK PIN (USED WITH FULL POWER TRIM)
21	76386		1	TILT LOCK ASSEMBLY (STARBOARD)
22	76385		1	TILT LOCK ASSEMBLY (PORT)
23	76387		1	TUBE, TILT LOCK
25	13-69150		1	WASHER WAVE - TILT LOCK (STARBOARD SIDE ONLY)
25A	26-22734		2	OIL SEAL, SWIVEL BRACKET (TILT LOCK)
25B	12-76388		1	WASHER, TILT LOCK (STARBOARD SIDE ONLY)
25C	25-62702	●	2	"O" RING, TILT LOCK
26	18-47959		2	COTTER PIN, TILT LOCK
27	70692		1	REVERSE LOCK ASSEMBLY NOT USED WITH FULL POWER TRIM
28	24-78203A1		1	SPRING, REVERSE LOCK TENSION NOT USED WITH FULL POWER TRIM
29	56349		1	SHAFT, REVERSE LOCK PIVOT NOT USED WITH FULL POWER TRIM

● = CONTENTS OF C-[27-85653A79] GASKET SET

CONTINUED ON NEXT PAGE ➡

CLAMP BRACKET AND REVERSE LOCK

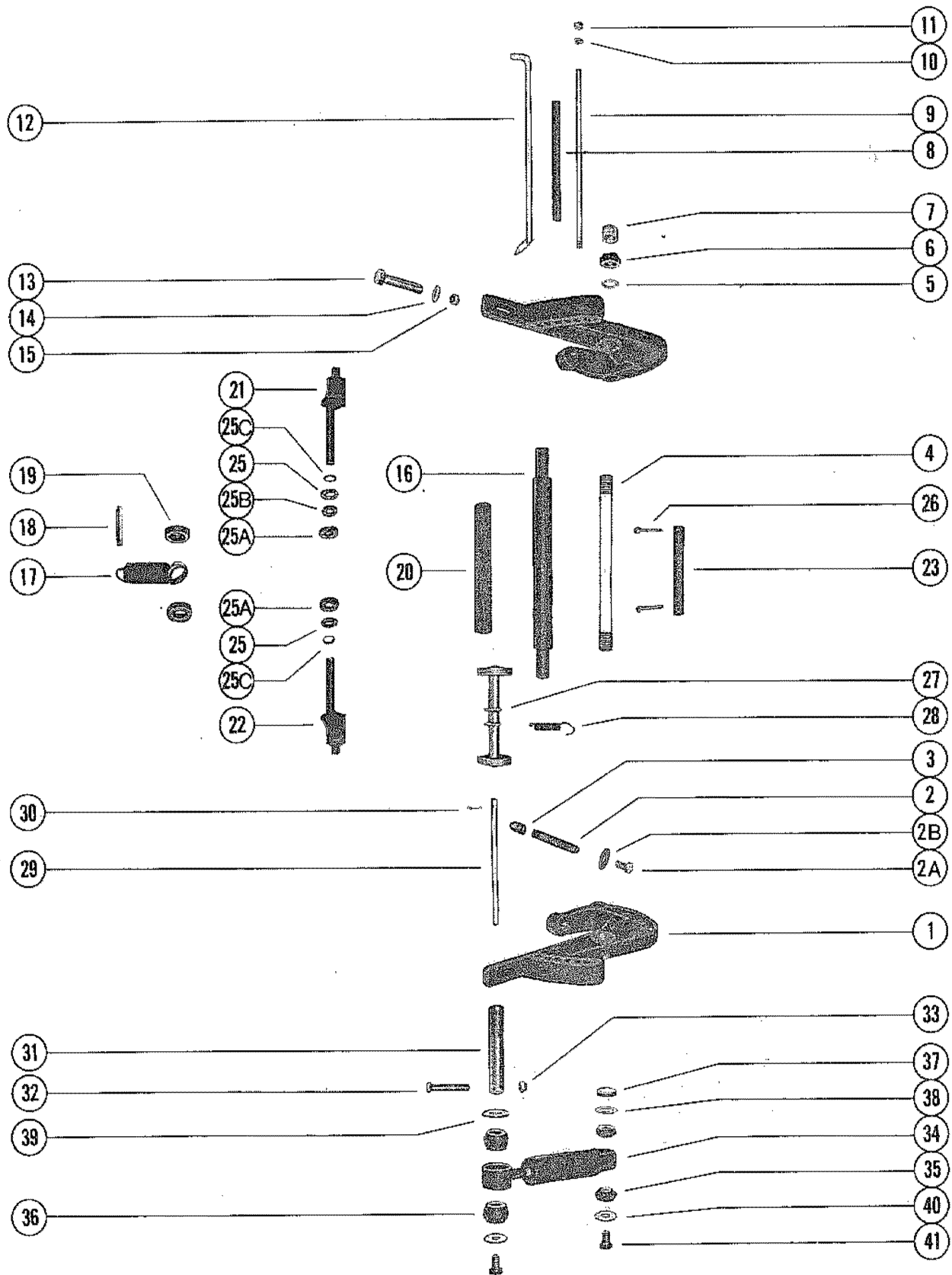

CLAMP BRACKET AND REVERSE LOCK

REF. NO.	PART NO.	SYM.	QTY.	DESCRIPTION
30	18-45882		1	COTTER PIN, REVERSE LOCK TO SHAFT NOT USED WITH FULL POWER TRIM
31	55-28414		2	PIN, LOWER SHOCK MOUNTING
32	10-21937		2	SCREW, LOWER SHOCK PIN
33	11-46887		2	NUT, LOWER SHOCK PIN SCREW
34	55-58780A2		2	SHOCK ABSORBER NOT USED WITH FULL POWER TRIM
35	23-32171		4	BUSHING, RUBBER - SHOCK ABSORBER (UPPER) NOT USED WITH FULL POWER TRIM
36	23-28198		4	BUSHING, RUBBER - SHOCK ABSORBER (LOWER) NOT USED WITH FULL POWER TRIM
37	23-73203		2	SPACER UPPER SHOCK BUSHING TO CLAMP BRACKET
38	12-28196		2	WASHER, UPPER BUSHING RETAINER (INNER)
39	12-59378		2	WASHER, LOWER BUSHING RETAINER (INNER)
40	12-69374		4	WASHER UPPER AND LOWER BUSHING RETAINER (OUTER)
41	10-69375		4	SCREW UPPER AND LOWER SHOCK MOUNTING PIN
-	27-85653A79		0	GASKET SET

DRIVE SHAFT HOUSING ASSEMBLY

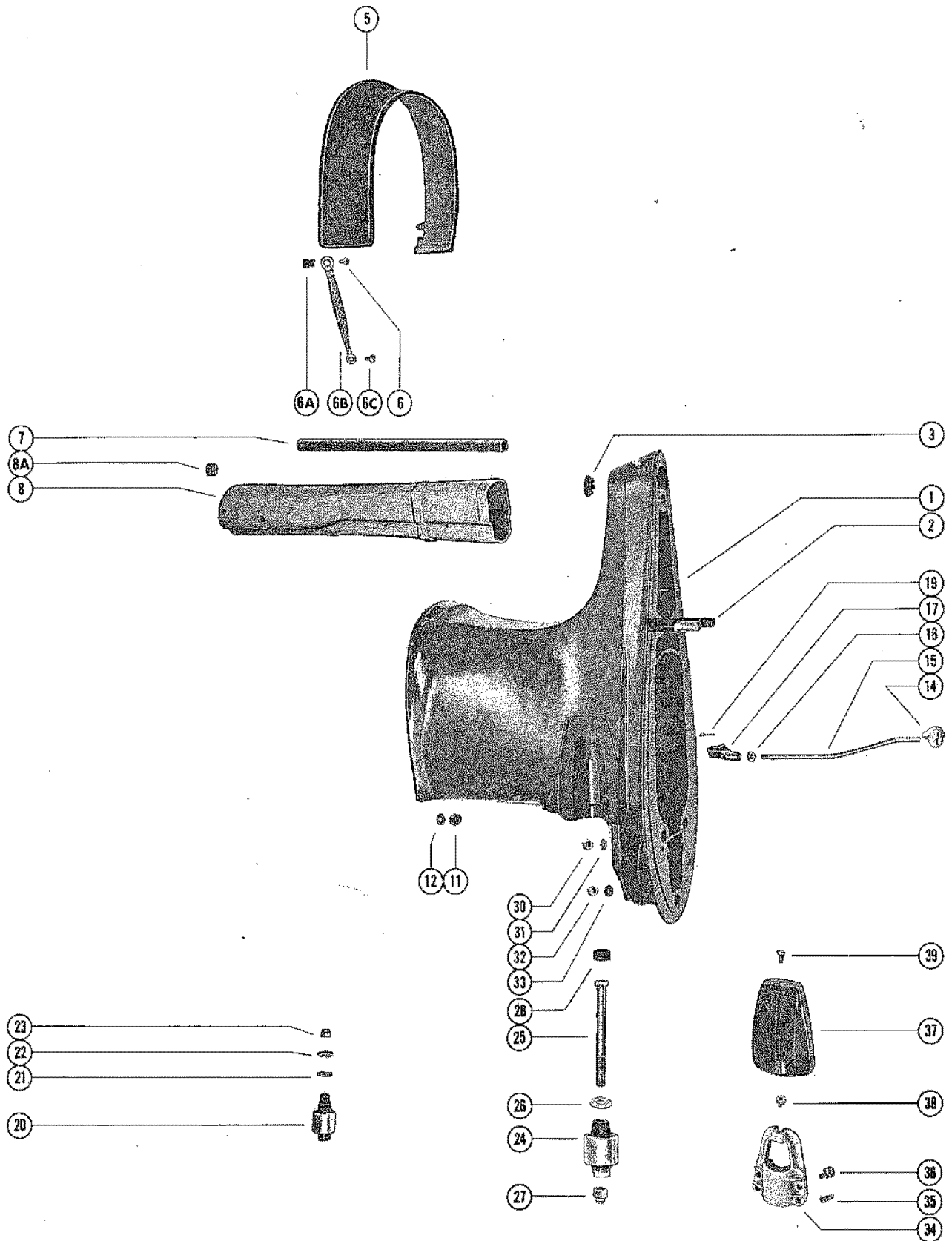

DRIVE SHAFT HOUSING ASSEMBLY

REF. NO.	PART NO.	SYM.	QTY.	DESCRIPTION
1	1573-5239A4		1	DRIVE SHAFT HOUSING ASSEMBLY
2	16-56295		2	STUD DRIVE SHAFT HOUSING TO GEAR HOUSING (2 11/16")
3	19-64649		1	PLUG, PLASTIC - TRIM TAB SCREW HOLE
5	37417		1	COVER, TRIM - DRIVE SHAFT HOUSING
6	10-57807		4	SCREW, TRIM COVER TO BOTTOM COWL
6A	25-57806		4	GROMMET, PLASTIC - TRIM COVER SCREW
6B	46933A2		2	GROUND STRAP ASSEMBLY, TRIM COVER SCREW
6C	10-62568		2	SCREW, GROUND STRAP ATTACHING
7	32-60897		1	TUBE, WATER INLET
8	78184		1	TUBE, EXHAUST
8A	65638		2	BOOT, TUBE MOUNT
11	11-69254		2	NUT, POWERHEAD STUDS (3/8-24)
12	12-25970		2	WASHER, POWERHEAD STUDS
14	52887		1	GUIDE, PUSH ROD - REVERSE LOCKING NOT USED WITH FULL POWER TRIM
15	47558		1	ROD, PUSH - REVERSE LOCK NOT USED WITH FULL POWER TRIM
16	11-47661		1	NUT, JAM - PUSH ROD NOT USED WITH FULL POWER TRIM
17	47559		1	YOKE, PUSH ROD NOT USED WITH FULL POWER TRIM
19	18-25191		1	COTTER PIN, PUSH ROD PIN NOT USED WITH FULL POWER TRIM
20	75296		2	MOUNT, RUBBER - UPPER
21	12-47840		2	WASHER, RUBBER - UPPER MOUNT BOLT
22	12-31263		2	WASHER, UPPER MOUNT BOLT
23	11-34933		2	NUT, UPPER MOUNT BOLT
24	75299		2	MOUNT, RUBBER - LOWER
25	10-49318		2	SCREW, LOWER MOUNT (5 1/2")
26	12-49339		2	WASHER, LOWER MOUNT SCREW
27	11-25096		2	NUT, LOWER MOUNT SCREW
28	25067		2	BUMPER, RUPPER - LOWER MOUNTING SCREW
30	11-34933		2	NUT GEAR HOUSING AND DRIVE SHAFT HOUSING STUDS
31	12-45176		2	WASHER GEAR HOUSING TO DRIVE SHAFT HOUSING STUDS
32	11-29489		1	NUT GEAR HOUSING AND DRIVE SHAFT HOUSING STUDS
33	12-45176		1	WASHER GEAR HOUSING TO DRIVE SHAFT HOUSING STUDS
34	35608		2	CLAMP, LOWER MOUNT TO DRIVE SHAFT HOUSING
35	24-35522		4	SPRING, TENSION - LOWER MOUNT CLAMP
36	10-29256		4	SCREW LOWER MOUNT CLAMP TO DRIVE SHAFT HOUSING
37	35474		2	COVER, LOWER MOUNT CLAMP
38	11-35521		2	NUT, LOWER MOUNT CLAMP COVER
39	10-29722		2	SCREW, COVER TO LOWER CLAMP MOUNT

GEAR HOUSING ASSEMBLY, COMPLETE

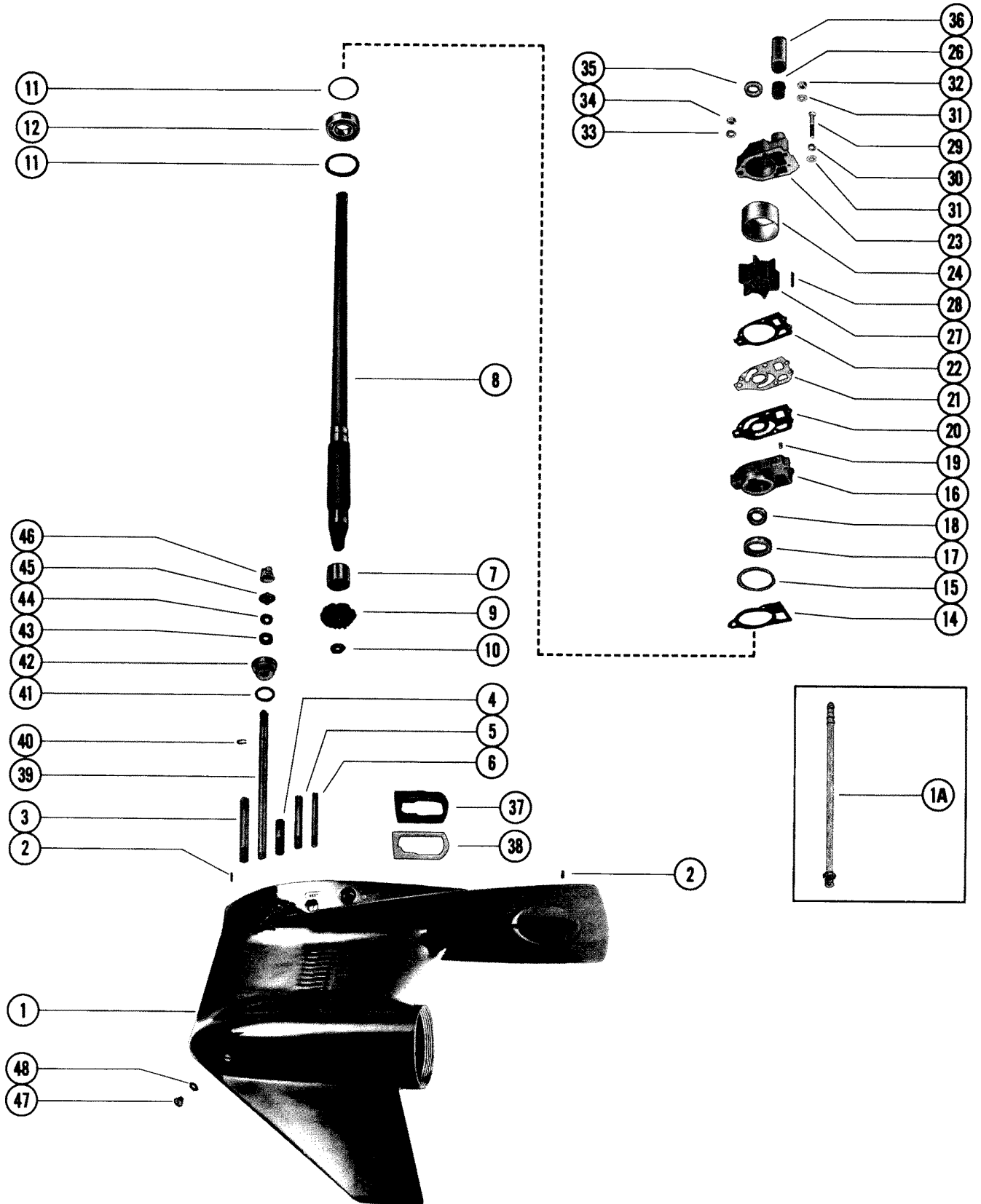

GEAR HOUSING ASSEMBLY, COMPLETE

REF. NO.	PART NO.	SYM.	QTY.	DESCRIPTION
-	1655-7333A24		1	GEAR HOUSING ASS'Y, COMP.(SEE NOT BELOW)
1	1655-7333A23		1	GEAR HOUSING ASS'Y
1A	22-85822A1		1	CONNECTOR ASSEMBLY, SPEEDOMETER
2	17-46912		2	DOWEL PIN, GEAR HOUSING LOCATING
3	16-57921		1	STUD GEAR HOUSING TO DRIVE SHAFT HOUSING (4")
4	16-57920		2	STUD GEAR HOUSING TO DRIVE SHAFT HOUSING (2 1/16")
5	16-56297		1	STUD WATER PUMP BASE AND BODY TO GEAR HOUSING (3 3/8")
6	16-30667		2	STUD WATER PUMP BASE AND BODY TO GEAR HOUSING (3 1/8")
7	31-32898		1	BEARING, ROLLER - DRIVE SHAFT
8	45-42646		1	DRIVE SHAFT
9	43-68548		1	GEAR, PINION - DRIVE SHAFT
10	11-35921		1	NUT, PINION GEAR TO DRIVE SHAFT
11	23-70412		1	SPACER, BALL BEARING TO BASE
	15-57007A1		AR	SHIM, BALL BEARING TO BASE
12	31-69220		1	ROLLER BEARING, DRIVE SHAFT
14	27-33146	●	1	GASKET, WATER PUMP BASE
15	25-33145	●	1	"O" RING, WATER PUMP BASE
16	46-73804A1		1	WATER PUMP BASE ASSEMBLY
17	26-31489		1	OIL SEAL, WATER PUMP BASE
18	26-31507		1	OIL SEAL, WATER PUMP BASE
19	17-35973		2	DOWEL PIN WATER PUMP BASE TO WATER PUMP BODY
20	27-32433	●	1	GASKET LOWER - WATER PUMP BASE TO FACE PLATE
21	32435		1	PLATE FACE - WATER PUMP BASE TO WATER PUMP BODY
22	27-32434	●	1	GASKET UPPER - FACE PLATE TO WATER PUMP BODY
23	46-64141A1		1	WATER PUMP BODY ASSEMBLY
24	48752		1	INSERT, WATER PUMP BODY
26	26-38970		1	SEAL, RUBBER - WATER INLET TUBE
27	47-65960		1	IMPELLER, WATER PUMP
28	28-56654		1	KEY, IMPELLER DRIVE
29	10-30720		1	SCREW WATER PUMP BODY TO GEAR HOUSING (2 1/4")
30	13-26992		1	LOCKWASHER, WATER PUMP BODY SCREW
31	12-29245		3	WASHER WATER PUMP BODY FASTENING SCREW AND STUD
32	11-35888		2	NUT, WATER PUMP FASTENING SCREW
33	12-36001		1	WASHER, WATER PUMP BODY FASTENING STUD
35	25-30271	●	1	RING, RUBBER CENTRIFUGAL SLINGER (DRIVE SHAFT)
36	23-29804		1	SLEEVE, GUIDE - WATER INLET TUBE
37	37641		1	SEAL, EXHAUST ELBOW
38	38051		1	PLATE, SUPPORT - EXHAUST TUBE SEAL

● = CONTENTS OF C-[27-85653A79] GASKET SET

CONTINUED ON NEXT PAGE ➡

GEAR HOUSING ASSEMBLY, COMPLETE

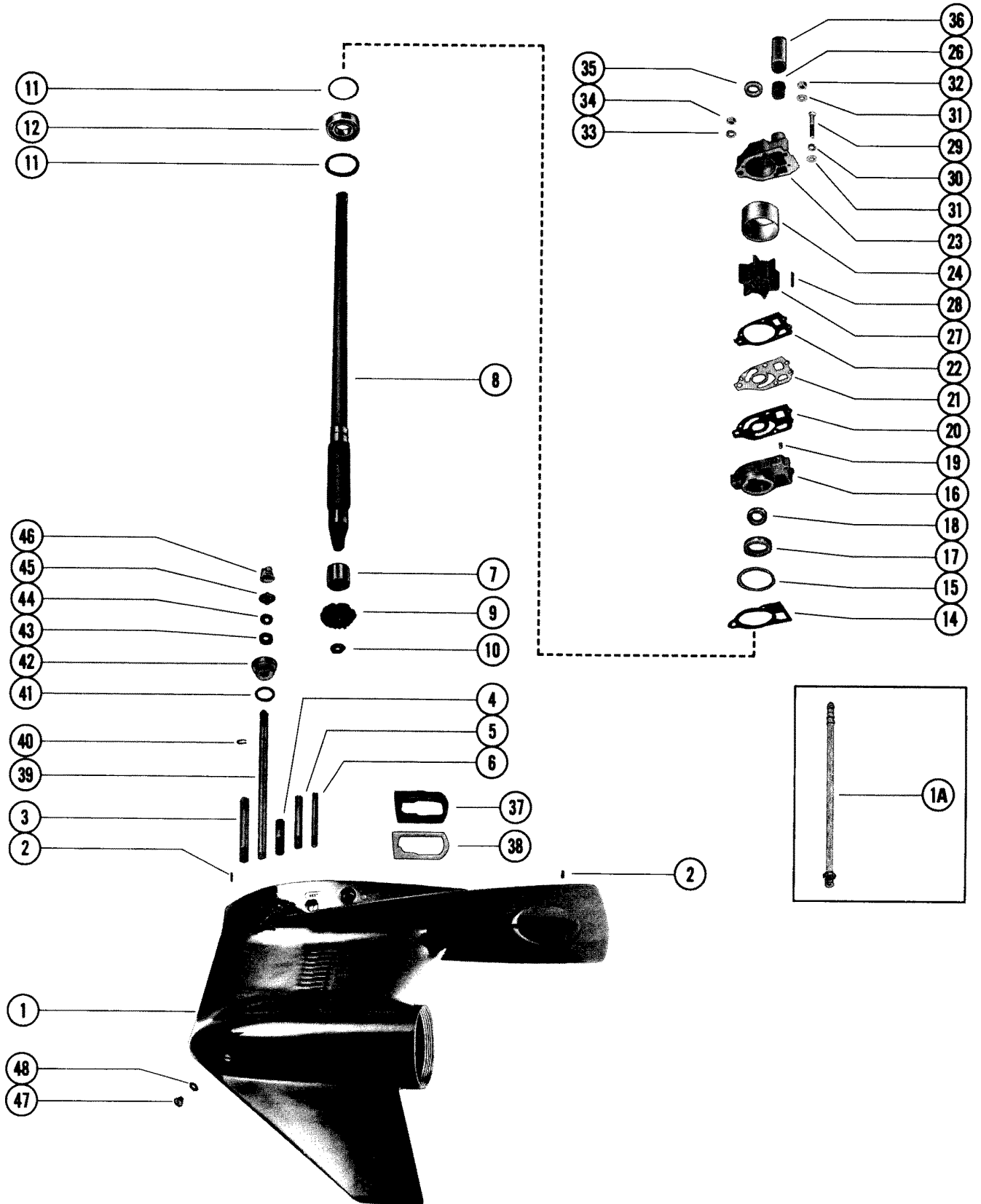

GEAR HOUSING ASSEMBLY, COMPLETE

REF. NO.	PART NO.	SYM.	QTY.	DESCRIPTION
39	76062A1		1	SHAFT ASSEMBLY, SHIFT - LOWER
40	53-29641		1	"E" RING, RETAINING - SHIFT SHAFT
41	25-25439	●	1	"O" RING, SHIFT SHAFT BUSHING
42	23-77631A2		1	BUSHING ASSEMBLY, SHIFT SHAFT
43	26-76384		1	OIL SEAL, SHIFT SHAFT BUSHING
44	12-77674		1	WASHER, RUBBER - SHIFT SHAFT BUSHING
45	39019		1	SPACER, LOWER - REVERSE LOCKING NOT USED WITH FULL POWER TRIM
46	39021		1	CAM, REVERSE LOCKING NOT USED WITH FULL POWER TRIM
47	10-79953		1	SCREW, GREASE FILLER AND VENT HOLE
	22-67892		1	PLUG, DRAIN (MAGNETIC)
48	12-20260		2	WASHER, GREASE FILLER AND VENT HOLE SCREW
-	27-85653A79		0	GASKET SET

THE ENCLOSED GEAR HOUSING INCLUDE ALL PARTS FROM REF. #1 THRU #71 AS LISTED UNDER "GEAR HOUSING ASSEMBLY, COMPLETE"

● = CONTENTS OF C-[27-85653A79] GASKET SET

GEAR HOUSING ASSEMBLY, COMPLETE

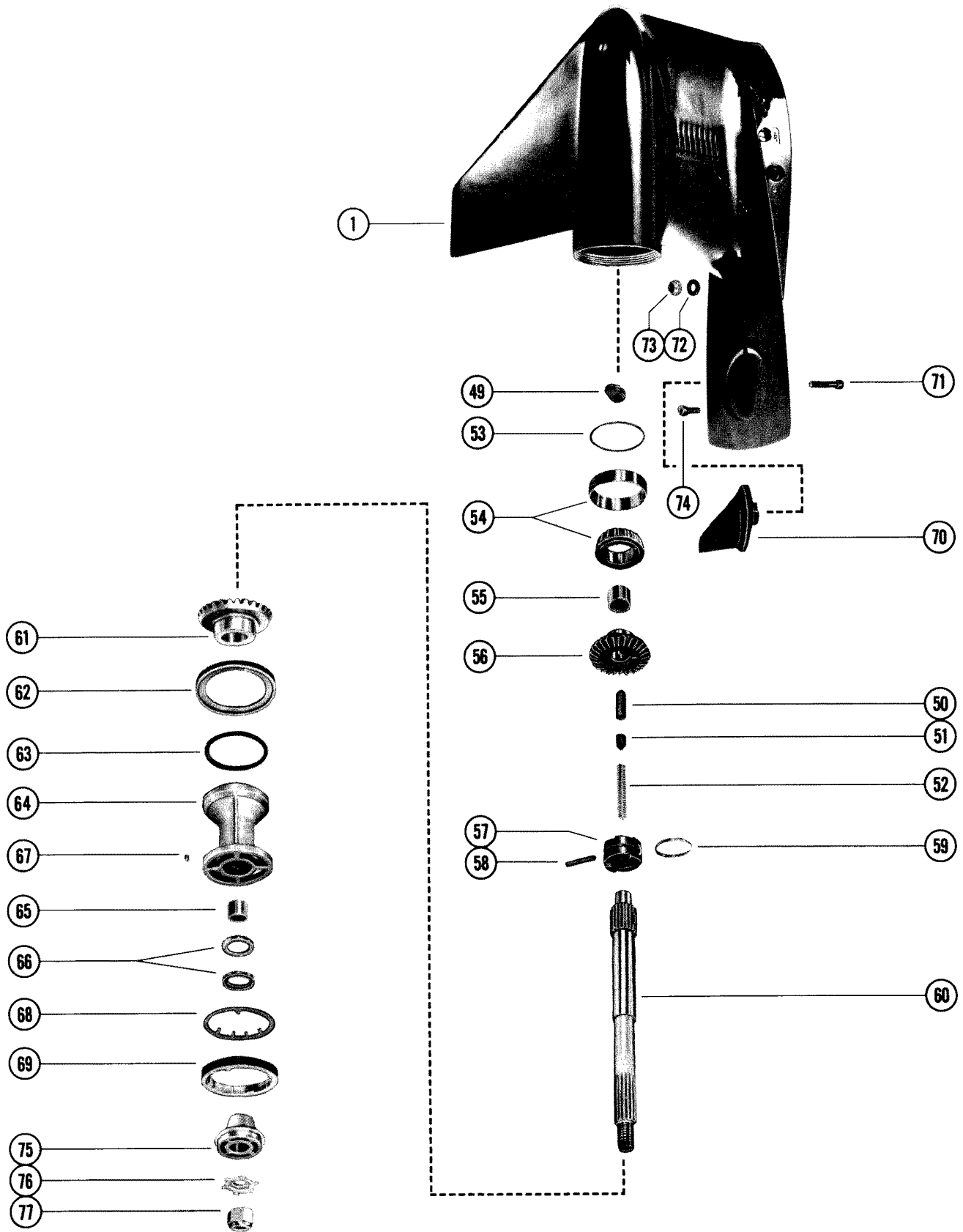

GEAR HOUSING ASSEMBLY, COMPLETE

REF. NO.	PART NO.	SYM.	QTY.	DESCRIPTION
-	1655-7333A24		1	GEAR HOUSING ASS'Y, COMP. THE ENCLOSED GEAR HOUSING INCLUDE ALL PARTS FROM REFERENCE #1 THRU #71 AS LISTED ON C10 AND C12
1	1655-7333A23		1	GEAR HOUSING ASS'Y
49	76039		1	CAM, SHIFT
50	30625		1	FOLLOWER, CAM
51	30624		1	SLIDE, CROSS PIN
52	24-30622		1	SPRING, COMPRESSION - CAM FOLLOWER
53	15-30923A1		AR	SHIM BEARING OUTER RACE TO HOUSING (.002-3-5-10)
54	31-30894A1		1	TAPERED ROLLER BEARING ASSEMBLY
55	31-30895		1	BEARING, ROLLER - FORWARD GEAR
56	43-68447		1	FORWARD GEAR
57	52-34239		1	RATCHET, SLIDING GEAR
58	17-30632		1	PIN, CROSS - RATCHET TO PROPELLER SHAFT
59	24-30893		1	SPRING, RETAINING - CROSS PIN
60	44-52542		1	SHAFT, PROPELLER
61	43-76250		1	REVERSE GEAR
62	12-76805		1	WASHER, THRUST BEARING CARRIER TO GEAR HOUSING
63	25-29976	●	1	"O" RING, BEARING CARRIER
64	77520A1		1	BEARING CARRIER ASSEMBLY
65	31-30956		1	BEARING, ROLLER - BEARING CARRIER
66	26-76868		2	OIL SEAL, BEARING CARRIER
67	28-30281		1	KEY, LOCATING - BEARING CARRIER
68	14-52700		1	TAB WASHER, GEAR HOUSING COVER
69	52699		1	COVER, GEAR HOUSING
70	31640A1		1	TRIM TAB, GEAR HOUSING
71	10-66024		1	SCREW, TRIM TAB TO GEAR HOUSING (1 3/4")
72	12-45176		2	WASHER GEAR HOUSING TO DRIVE SHAFT HOUSING STUDS
73	11-34933		2	NUT GEAR HOUSING TO DRIVE SHAFT HOUSING STUDS
74	10-65210		1	SCREW GEAR HOUSING TO DRIVE SHAFT HOUSING (1")
75	75282		1	THRUST HUB
76	14-31210		1	TAB WASHER, PROPELLER NUT
77	11-52707		1	NUT, PROPELLER
-	27-85653A79		0	GASKET SET

THE ENCLOSED GEAR HOUSING INCLUDE ALL PARTS FROM REF. #1 THRU #71 AS LISTED UNDER "GEAR HOUSING ASSEMBLY, COMPLETE"

● = CONTENTS OF C-[27-85653A79] GASKET SET

HYDRAULIC PUMP ASSEMBLY

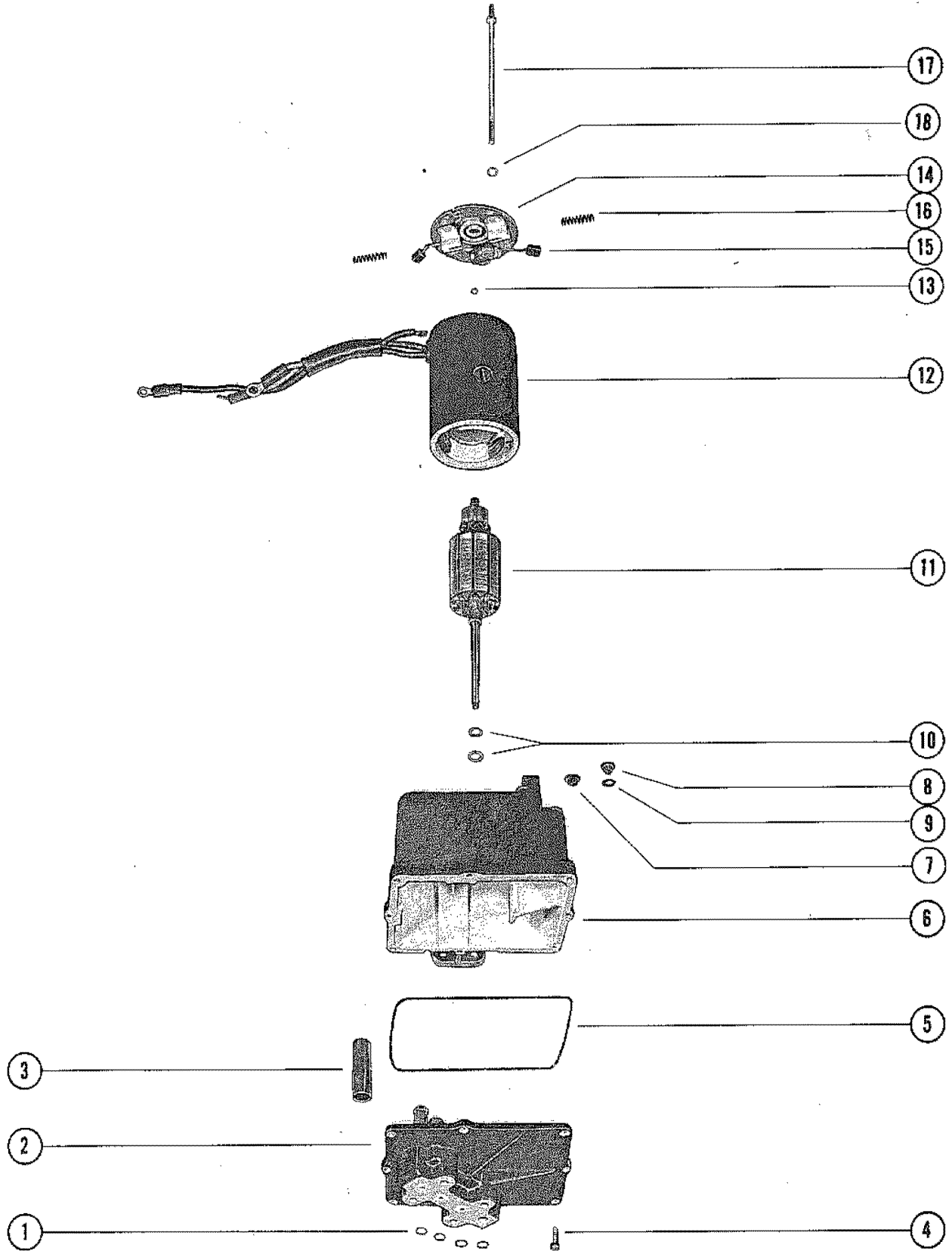

HYDRAULIC PUMP ASSEMBLY

REF. NO.	PART NO.	SYM.	QTY.	DESCRIPTION
-	76395A5		1	HYDRAULIC PUMP ASSEMBLY, COMPLETE
1	25-21720		4	"O" RING, HYDRAULIC PUMP
2	392-2936		1	VALVE BODY AND GEAR ASSEMBLY
3	392-2618		2	CAN, VALVE BODY
4	10-20411		8	SCREW, VALVE BODY TO RESERVIOR
5	392-2937		1	SEAL, RESERVOIR TO VALVE BODY AND GEAR
6	392-2939		1	RESEVOIR ASSEMBLY
7	10-38257		1	SCREW, VENT - HYDRAULIC PUMP
8	10-28634		1	SCREW, FILLER - HYDRALIC PUMP
9	12-20260		1	WASHER, SEALING - FILLER SCREW
10	392-2623		AR	WASHER, THRUST - ARMATURE
11	392-2943		1	ARMATURE, FIELD AND FRAME
12	392-2942		1	FIELD AND FRAME ASSEMBLY
13	392-2944		1	BALL, COMMUTATOR END PLATE
14	392-2940		1	PLATE ASSEMBLY, COMMUTATOR END
15	392-2941		1	BRUSH SET, COMMUTATOR END PLATE
16	392-2529		1	SPRING SET, BRUSH TENSION
17	392-2938		1	BOLT SET THUR - PLATE AND FRAME TO RESERVIOR
18	13-26996		2	LOCKWASHER, THRU BOLT

HYDRAULIC PUMP AND CONTROL VALVE

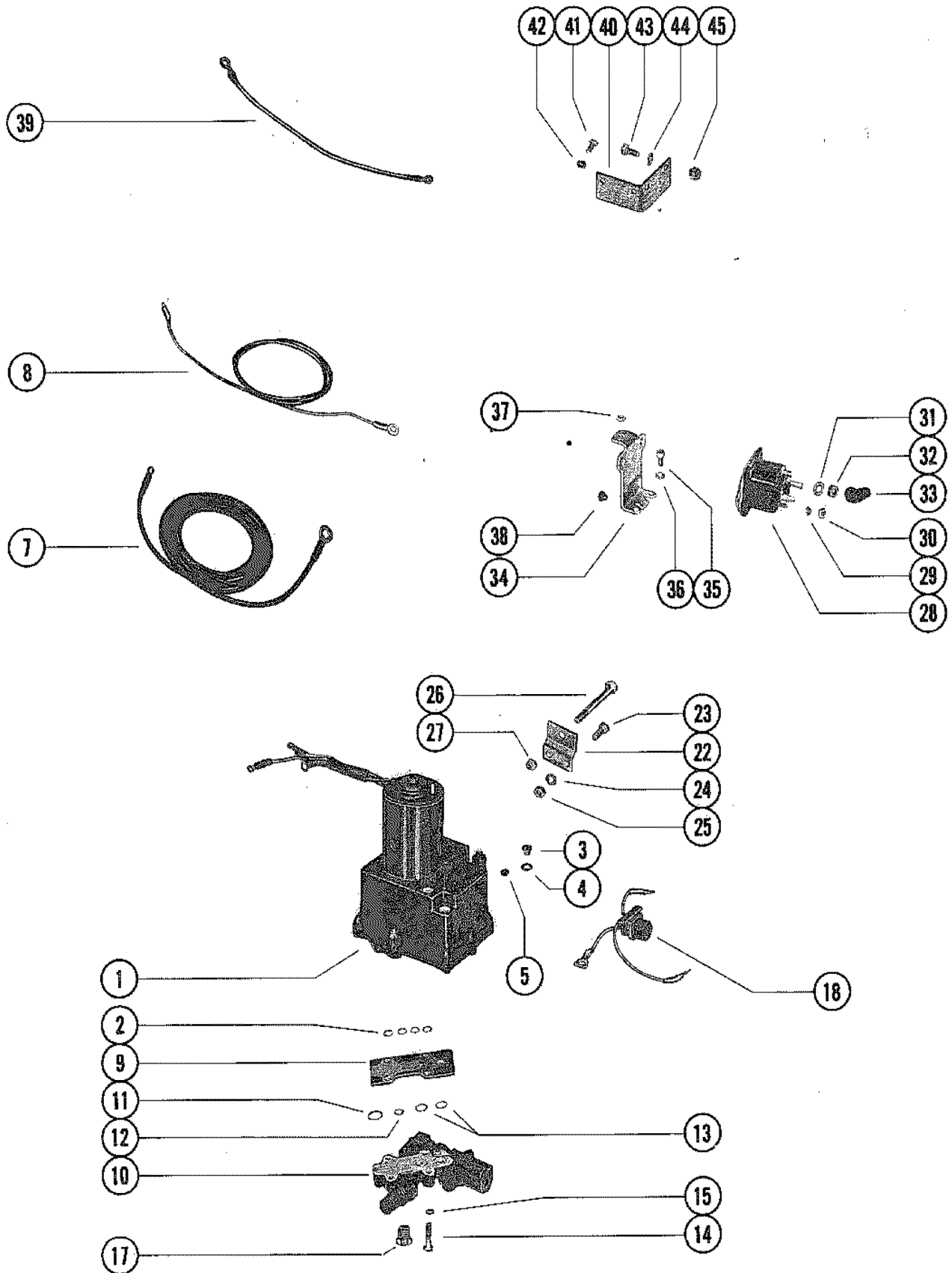

HYDRAULIC PUMP AND CONTROL VALVE

REF. NO.	PART NO.	SYM.	QTY.	DESCRIPTION
1	76395A5		1	HYDRAULIC PUMP ASSEMBLY SEE C14 FOR BREAKDOWN
2	25-21720		4	"O" RING, HYDRAULIC PUMP TO MANIFOLD PLATE
3	10-28634		1	SCREW, FILLER - HYDRAULIC PUMP
4	12-20260		1	WASHER, SEALING - HYDRAULIC PUMP FILLER SCREW
5	10-38257		1	SCREW, VENT - HYDRAULIC PUMP
7	32979		1	BATTERY LEAD (POSITIVE)
8	32988		1	BATTERY LEAD (NEGATIVE)
9	45336		1	PLATE, MANIFOLD
10	45197A2		1	CONTROL VALVE ASSEMBLY
-	25-21720		4	"O"RING PUMP TO MANIFOLD PLATE (SEE REFERENCE #2)
11	25-45254		1	"O" RING CONTROL VALVE TO MANIFOLD PLATE (3/4" O.D.)
12	25-21720		1	"O"RING CONTROL VALVE TO MANIFOLD PLATE (1/2" O.D.)
13	25-45253		2	"O"RING CONTROL VALVE TO MANIFOLD PLATE (5/8" O.D.)
14	10-56500		4	SCREW VALVE AND MANIFOLD PLATE TO PUMP (1 1/4")
15	13-26992		4	LOCKWASHER CONTROL VALVE AND MANIFOLD PLATE SCREW
17	22-46008		2	PLUG, CONTROL VALVE (1/2-20")
18	84-74023		1	CONNECTOR AND HARNESS
22	45377		2	BRACKET, MOUNTING - HYDRAULIC PUMP TO BOAT
23	10-24234		4	SCREW MOUNTING BRACKET TO HYDRAULIC PUMP (1")
24	13-39107		4	LOCKWASHER, MOUNTING BRACKET SCREW
25	11-21908		4	NUT, MOUNTING BRACKET SCREW
26	10-68298		2	BOLT, HYDRAULIC PUMP TO BOAT (3 1/4")
27	11-68411		2	NUT, HYDRAULIC PUMP BOLT
28	89-68258		2	STARTER SOLENOID
29	13-26996		4	LOCKWASHER STARTER SOLENOID TERMINAL (#10)
30	11-68219		4	NUT, STARTER SOLENOID TERMINAL (#10)
31	13-26993		4	LOCKWASHER STARTER SOLENOID TERMINAL (5/16")
32	11-68292		4	NUT, STARTER SOLENOID TERMINAL (5/16")
33	46265		4	BOOT, RUBBER - STARTER SOLENOID TERMINAL
34	74407		1	BRACKET, MOUNTING - STARTER SOLENOID
35	10-21140		2	SCREW MOUNTING BRACKET TO HYDRAULIC PUMP (1/2")
36	13-26992		2	LOCKWASHER, MOUNTING BRACKET SCREW
37	11-24656		1	NUT MOUNTING BRACKET TO HYDRAULIC PUMP THRU BOLT
38	26901		1	BUMPER, RUBBER - SOLENOID BRACKET
39	55991		1	BATTERY LEAD (POSITIVE)
	55992		1	BATTERY LEAD (NEGATIVE)
40	74406		1	BRACKET, MOUNTING - STARTER SOLENOID

CONTINUED ON NEXT PAGE ➡

HYDRAULIC PUMP AND CONTROL VALVE

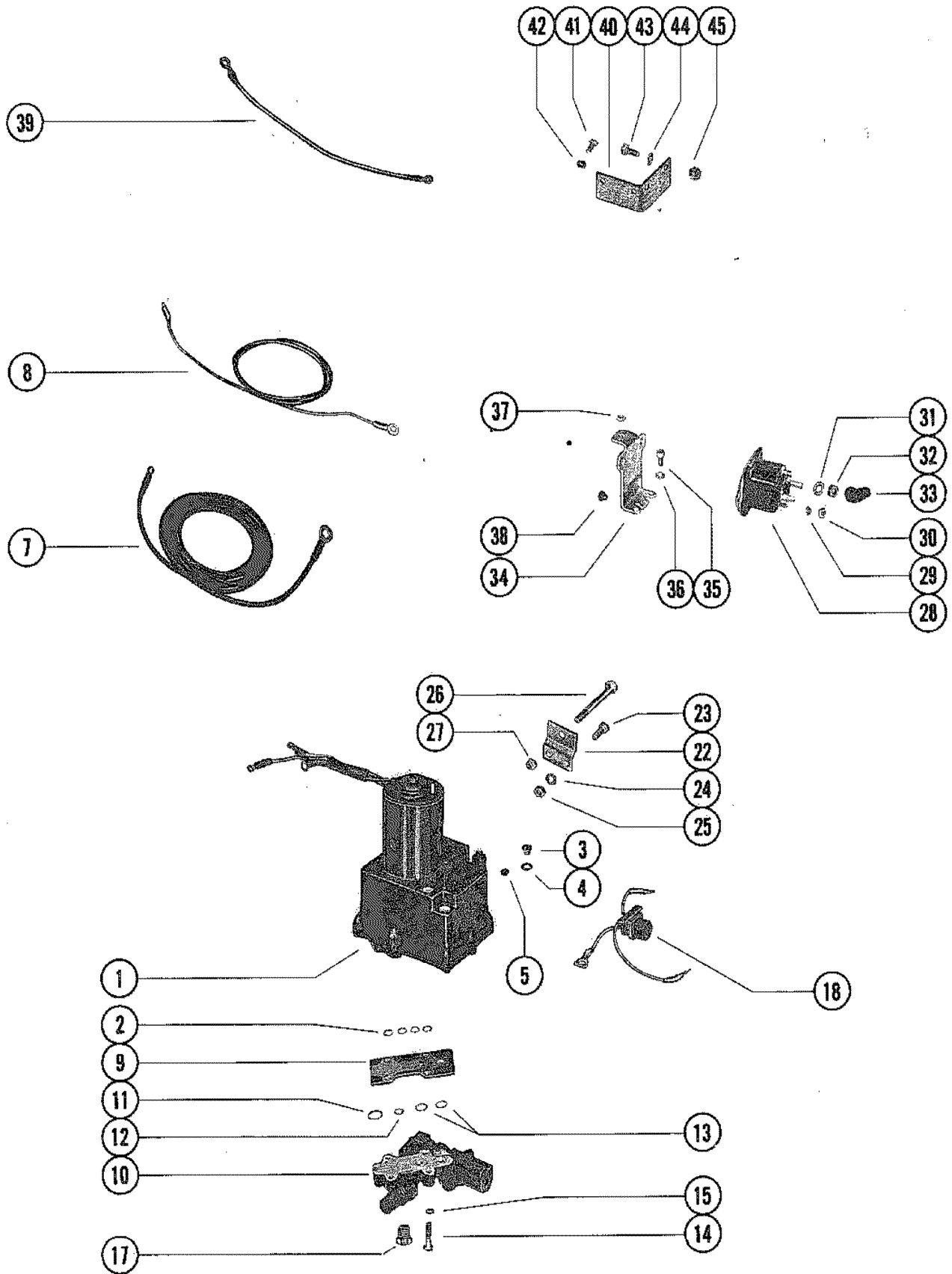

HYDRAULIC PUMP AND CONTROL VALVE

REF. NO.	PART NO.	SYM.	QTY.	DESCRIPTION
41	10-69028		2	SCREW MOUNTING BRACKET TO HYDRAULIC PUMP (3/4")
42	13-26992		2	LOCKWASHER, MOUNTING BRACKET SCREW
43	10-34290		2	SCREW STARTER SOLENOID TO MOUNTING BRACKET (5/8")
44	13-26992		2	LOCKWASHER, STARTER SOLENOID SCREW
45	11-21825		4	NUT, STARTER SOLENOID SCREW

SEE "HYDRAULIC PUMP ASSEMBLY" FOR BREAKDOWN

TRIM CYLINDERS AND HYDRAULIC HOSES

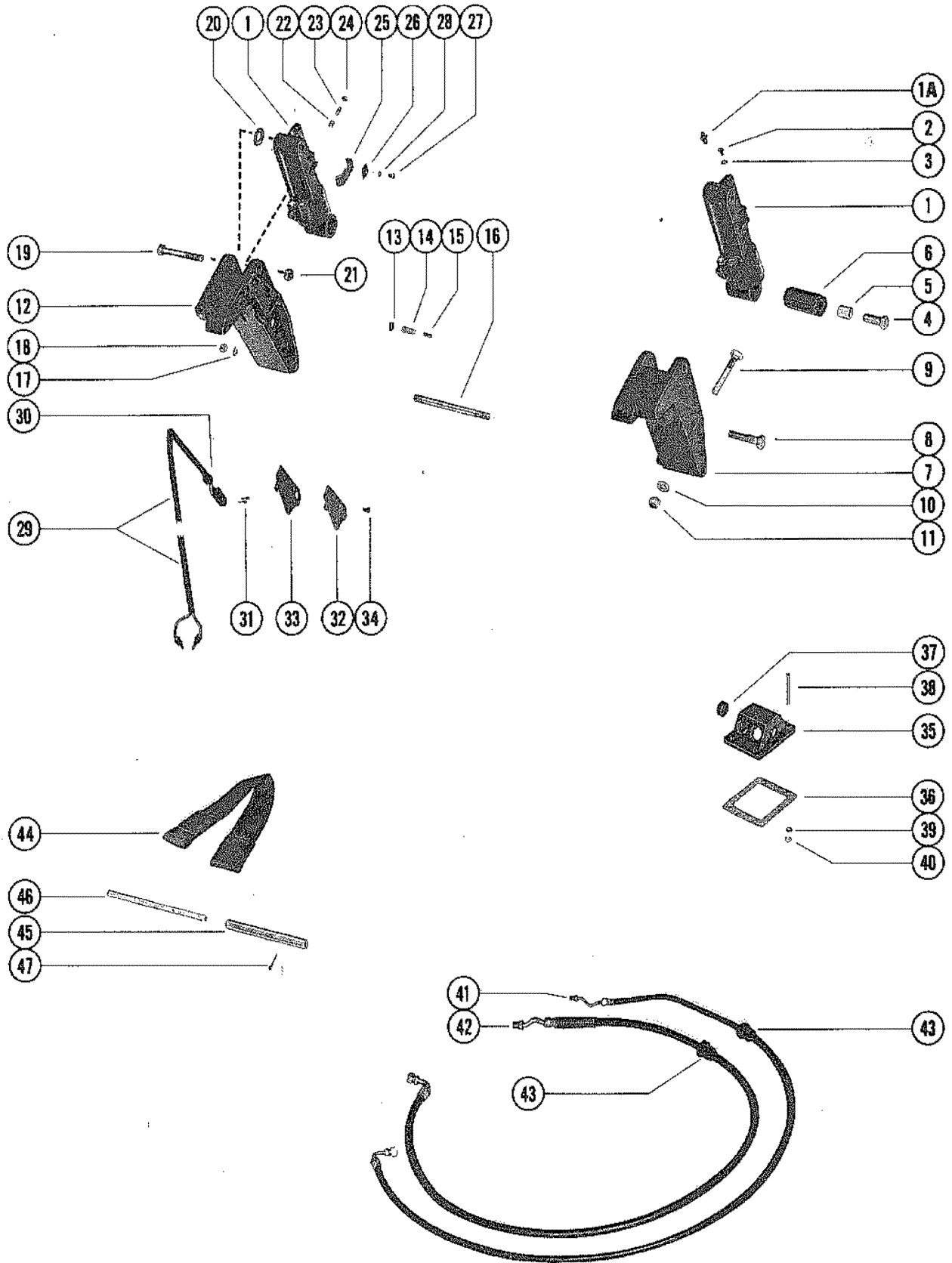

TRIM CYLINDERS AND HYDRAULIC HOSES

REF. NO.	PART NO.	SYM.	QTY.	DESCRIPTION
1	76509A3		2	TRIM CYLINDER ASSEMBLY
1A	22-74036		2	GREASE FITTING
2	10-45265		4	SCREW, BLEED - SHOCK CYLINDER
3	25-45016		4	"O" RING, SCHOCK CYLINDER BLEED SCREW
4	10-45264		2	SCREW SHOCK CYLINDER TO LOWER SHOCK PIN (1 9/16")
5	23-45280		2	SPACER, SHOCK CYLINDER - LOWER
6	23-45281		2	BUSHING, RUBBER - SHOCK CYLINDER
7	66084		1	BRACKET, MOUNTING - SHOCK CYLINDER (PORT)
8	10-45263		2	SCREW MOUNTING BRACKET TO UPPER SHOCK PIN (2 1/4")
9	10-68298		4	BOLT MOUNTING BRACKET TO BOAT TRANSOM (3 1/4")
10	12-68410		4	WASHER, MOUNTING BRACKET BOLT
11	11-68411		4	NUT, MOUNTING BRACKET BOLT
12	45196A2		1	BRACKET ASSEMBLY, MOUNTING - SHOCK CYLINDER (STARBOARD)
13	26-70608		1	OIL SEAL, STARBOARD MOUNTING BRACKET
14	45286		1	PLUNGER, LIMIT SWITCH ACTUATING
15	24-45272		1	SPRING, TENSION - LIMIT SWITCH PLUNGER
16	16-45282		1	STUD, MOUNTING BRACKET AND CLAMP BRACKET
17	13-26993		2	LOCKWASHER MOUNTING BRACKET TO CLAMP BRACKET STUD
18	11-28770		2	NUT MOUNTING BRACKET TO CLAMP BRACKET STUD
19	10-45328		2	SCREW SCHOCK CYLINDER TO MOUNTING BRACKET (3 9/16")
20	12-37807		1	WASHER SHOCK CYLINDER SCREW (STARBOARD ONLY)
21	11-20696		2	NUT, SHOCK CYLINDER SCREW
22	24-24390		1	SPRING, TENSION - ADJUSTING STUD
23	16-21085		1	STUD, ADJUSTING - CUT-OUT LIMIT SWITCH (15/16")
24	11-45812		1	NUT, JAM - LIMIT SWITCH ADJUSTING STUD
25	45508		1	CAM, LIMIT SWITCH ADJUSTING STUD
26	86967		1	PLATE, RETAINING - LIMIT SWITCH CAM
27	10-68513		1	SCREW RETAINING PLATE AND CAM TO SHOCK CYLINDER (3/8")
28	13-26996		1	LOCKWASHER, RETAINING PLATE AND CAM SCREW
29	45326A2		1	SWITCH ASSEMBLY, CUT-OUT LIMIT
30	23-45354		1	BUSHING, RUBBER - CUT-OUT LIMIT SWITCH
31	10-47255		2	SCREW CUT-OUT LIMIT SWITCH TO MOUNTING BRACKET (9/16")
32	45287		1	COVER, LIMIT SWITCH
33	27-45275		1	GASKET, LIMIT SWITCH COVER
34	10-24942		5	SCREW LIMIT SWITCH COVER TO MOUNTING BRACKET (7/16")
35	45289		1	COVER, INLET - TRANSOM
36	27-45274		1	GASKET, INLET COVER
37	25-45507		1	GROMMET, RUBBER - INLET COVER
38	10-32866		4	SCREW, INLET COVER TO BOAT (2")

CONTINUED ON NEXT PAGE ➡

TRIM CYLINDERS AND HYDRAULIC HOSES

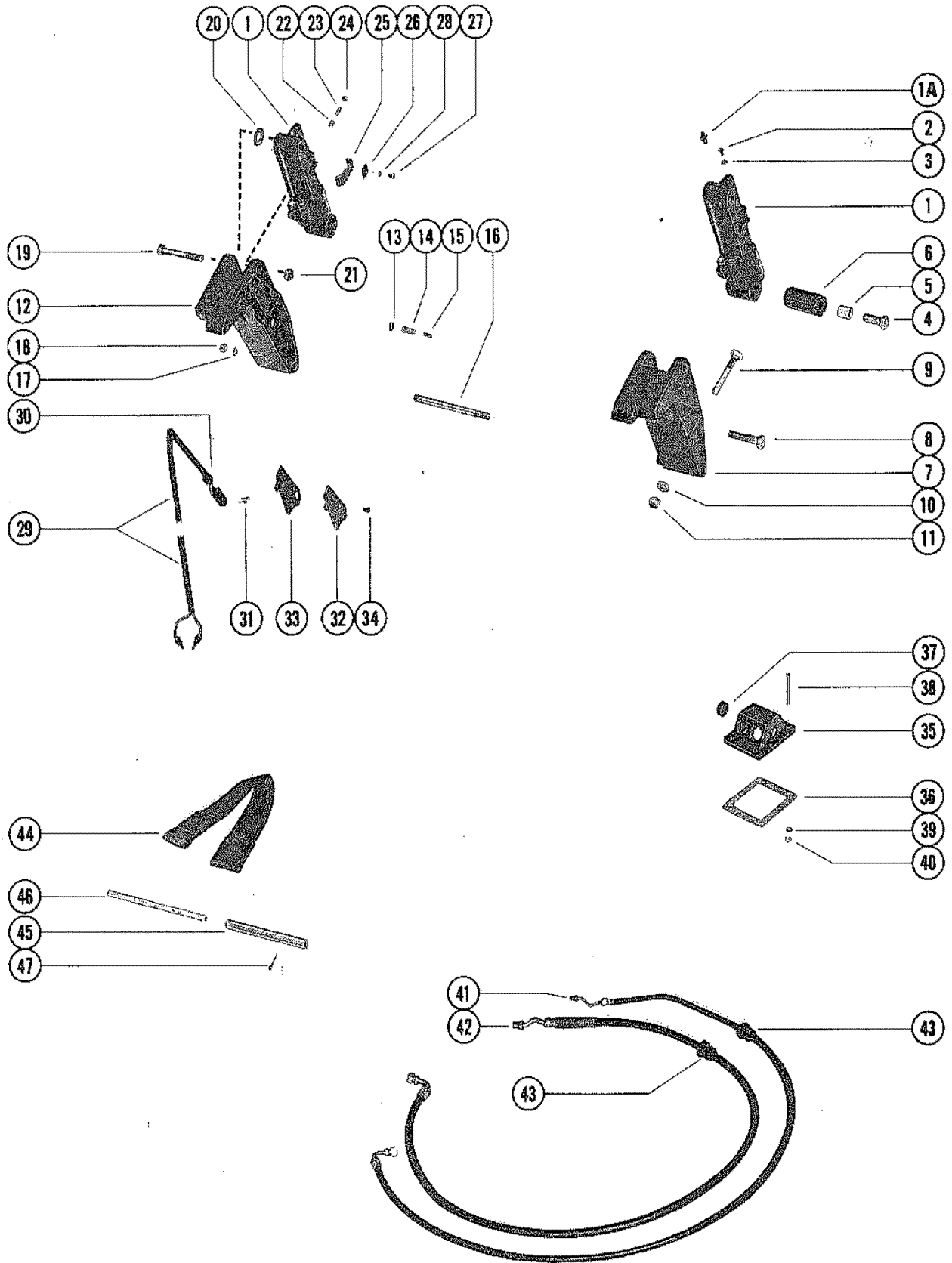

TRIM CYLINDERS AND HYDRAULIC HOSES

REF. NO.	PART NO.	SYM.	QTY.	DESCRIPTION
39	12-20878		4	WASHER, INLET COVER SCREW
40	11-29488		4	NUT, INLET COVER SCREW
41	32-45327		2	HOSE TRIM - CYLINDER TO CONTROL VALVE (5') - 13/32" O.D.
42	32-45959		2	HOSE LIFT - CYLINDER TO CONTROL VALVE (5') - 17/32" O.D.
43	23-35977		4	GROMMET, RUBBER - LIFT HOSE AND TRIM HOSE
44	73519A1		1	TILT STOP
45	69259		1	TUBE, MOUNTING - TILT STOP
46	77669		1	PIN, MOUNTING TUBE
47	18-36391		1	COTTER PIN, MOUNTING TUBE PIN

POWER TRIM CYLINDER REPAIR KITS

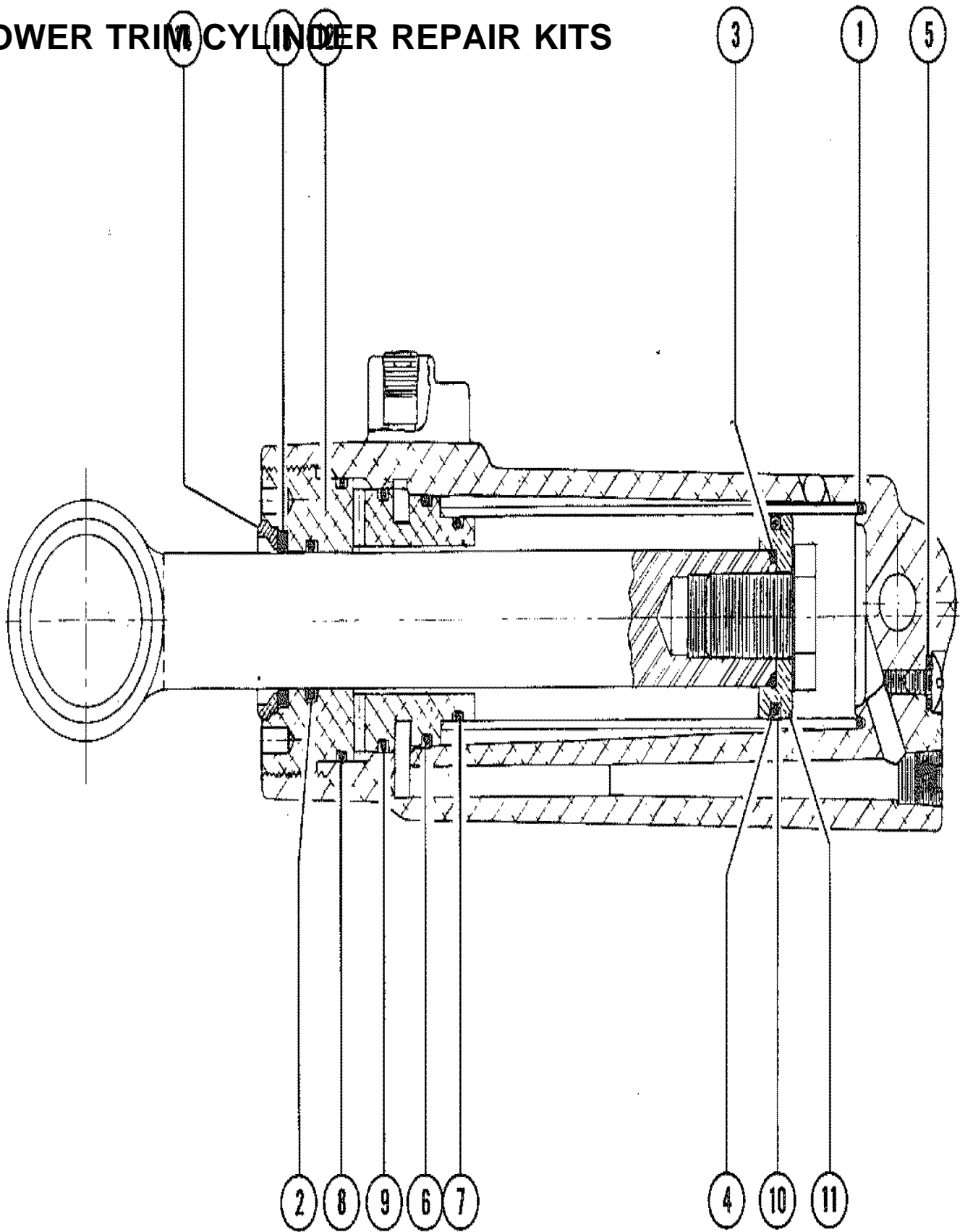

POWER TRIM CYLINDER REPAIR KITS

REF. NO.	PART NO.	SYM.	QTY.	DESCRIPTION
-	64507A1		1	REPAIR KIT
1	N.S.S.		1	"O" RING (1 1/2" X 1 1/5" X 1/16")
2	N.S.S.		1	"O" RING (3/4" X 15/16" X 1/8")
3	N.S.S.		1	"O" RING (5/8" X 3/4" X 1/16")
4	N.S.S.		1	"O" RING (1 1/4" X 1 7/16" X 1/16")
5	N.S.S.		2	"O" RING (7/32" X 11/32" X 1/16")
6	N.S.S.		1	"O" RING (1 5/8" X 1 13/16" X 1/8")
7	N.S.S.		1	"O" RING (1 5/16" X 1 1/2" X 1/8")
8	N.S.S.		1	"O" RING (1 7/8" X 2" X 1/8")
9	N.S.S.		1	"O" RING (1 3/4" X 1 15/16" X 1/8")
10	N.S.S.		1	SEAL, SLIPPER - PISTON
11	N.S.S.		1	PISTON, ROD - HEAVY DUTY
12	64505A1		1	RETAINER ASSEMBLY, PISTON
13	N.S.S.		1	ROD, SCRAPER
14	N.S.S.		1	RETAINER, SCRAPER

DO NOT SUBSTITUTE "O" RINGS AS THESE ARE OF SPECIAL MANUFACTURED MATERIAL.

PROPELLERS (RIGHT HAND ROTATION)

REF. NO.	PART NO.	SYM.	QTY.	DESCRIPTION
-	48-77338A4		0	PROPELLER ASSEMBLY (ALUMINUM)(PITCH 11") 3 BLADES
-	48-77340A4		0	PROPELLER ASSEMBLY (ALUMINUM)(PITCH 13") 3 BLADES
-	48-77342A4		0	PROPELLER ASSEMBLY (ALUMINUM)(PITCH 15") 3 BLADES
-	48-77344A4		0	PROPELLER ASSEMBLY (ALUMINUM)(PITCH 17") 3 BLADES
-	48-77346A4		0	PROPELLER ASSEMBLY (ALUMINUM)(PITCH 19") 3 BLADES
-	48-77348A4		0	PROPELLER ASSEMBLY (ALUMINUM)(PITCH 21") 3 BLADES
-	48-77350A4		0	PROPELLER ASSEMBLY (ALUMINUM)(PITCH 23") 3 BLADES

PARTS INDEX

Part Number	Description	Pg.	Ref. No.	Part Number	Description	Pg.	Ref. No.
22833	ADAPTOR, CHECK UNIT (FUEL LINE)	21	28	39021	CAM, REVERSE LOCKING	43	46
23004	RETAINER, CHECK VALVE	21	11	39519	CAP, BARREL RETAINER - ANCHOR BRACKET	29	25
23069	STEM, CHECK UNIT ADAPTOR	21	29	39616	BOOT, CONTROL CABLES - BOTTOM COWL	29	6
25067	BUMPER, RUBBER - LOWER MOUNTING SCREW	39	28	39618	LEVER, NYLON - SHIFT CABLE LOCKING	29	26
26113	RACE, OUTER (PAIR)	27	10	39667	COVER, NYLON - SHIFT CABLE	29	28
26901	BUMPER, RUBBER - SOLENOID BRACKET	49	38	45196A2	BRACKET ASSEMBLY, MOUNTING - SHOCK CYLINDER (STARBOARD)	53	12
28203	BUMPER, STEERING ARM	33	17	45197A2	CONTROL VALVE ASSEMBLY	49	10
28205	STRAP STOP	33	11	45286	PLUNGER, LIMIT SWITCH ACTUATING	53	14
30021	BLANKET, SOUND ABSORBING	5	14	45287	COVER, LIMIT SWITCH	53	32
30188	CUP WASHER, ADAPTOR	21	32	45289	COVER, INLET - TRANSOM SWITCH ASSEMBLY, CUT- OUT LIMIT	53	29
30413	HOOK, COWL LATCH FASTENING	5	13	45326A2	PLATE, MANIFOLD	49	9
30624	SLIDE, CROSS PIN	45	51	45336	BRACKET, MOUNTING - HYDRAULIC PUMP TO BOAT	49	22
30625	FOLLOWER, CAM	45	50	45377	CAM, LIMIT SWITCH ADJUSTING STUD	53	25
31014	MOUNT, RUBBER - REAR SUPPORT BRACKET	3	21	45508	MOUNT, RUBBER - TOP COWL FRAME	3	18
31089	STRIP, SOUND ABSORBING	5	7	46096	BOOT, RUBBER - STARTER SOLENOID TERMINAL	49	33
31640A1	TRIM TAB, GEAR HOUSING	45	70	46265	COWL LATCH ASSEMBLY	5	12
32435	PLATE	41	21	46785A1	GROUND STRAP ASSEMBLY, TRIM COVER SCREW	39	6B
32979	BATTERY LEAD (POSITIVE)	49	7	46933A2	GROUND STRAP ASSEMBLY	25	33
32988	BATTERY LEAD (NEGATIVE)	49	8	47341A1	ROPE, STARTER (FOR MANUAL STARTING ONLY)	3	9
35474	COVER, LOWER MOUNT CLAMP	39	37	47558	ROD, PUSH - REVERSE LOCK	39	15
35496	PAD, BUMPER - TOP COWL RETAINER	3	3	47559	YOKE, PUSH ROD	39	17
35608	CLAMP, LOWER MOUNT TO DRIVE SHAFT HOUSING	39	34	48039	CAP, NYLON - ADJUSTING SCREW	9	33
35769	SEAL, SOUND ABSORBING - UPPER	5	9	48047A1	LINK ROD ASSEMBLY	29	20
37417	COVER, TRIM - DRIVE SHAFT HOUSING	39	5	48152	SHUTTER, CHOKE - CARBURETOR	15	25
37440	BRACKET, MOUNT SUPPORT - CYLINDER BLOCK	25	28	48203	ROD, CHOKE	15	22
37445	SUPPORT, WIRING HARNESS - BOTTOM COWL	29	10	48752	INSERT, WATER PUMP BODY	41	24
37587	SWIVEL, THROTTLE LEVER TO THROTTLE CABLE	9	6	49589	STRAP, CHOKE KNOB TO CHOKE ROD	15	19
37637	BOOT, FUEL CONNECTOR - BOTTOM COWL	29	9	52023	CAP, NYLON - ADJUSTING SCREW	9	10
37640	MOUNT, RUBBER FRONT SUPPORT BRACKET	3	34	52023	CAP, NYLON - ADJUSTING SCREW	9	30
37641	SEAL, EXHAUST ELBOW	41	37	52100	WEAR PLATE, LINK ROD	29	33
3786	GUIDE BLOCK, LINK ROD	29	32	52699	COVER, GEAR HOUSING	45	69
37918	SEAL, EXHAUST EXTENSION PLATE	31	3	52732	BRACKET, ANCHOR - CONTROL CABLES	29	24
37940	PAD, SOUND - DRIP TRAY	29	3				
38032	STRIP, RETAINING	31	4				
38051	PLATE, SUPPORT - EXHAUST TUBE SEAL	41	38				
38279	LATCH	29	34				
38674	BAG, STARTER ROPE	5	8				
39019	SPACER, LOWER - REVERSE LOCKING	43	45				

PARTS INDEX

Part Number	Description	Pg.	Ref. No.	Part Number	Description	Pg.	Ref. No.
52737	LEVER, COWL LATCH HINGE	3	11	70692	REVERSE LOCK ASSEMBLY	35	27
52739	HINGE, COWL LATCH - TOP COWL	3	10	71808	COVER, WATER JACKET - CYLINDER BLOCK	25	13
52862A2	DRIP TRAY ASSEMBLY, BOTTOM COWL	29	2	73218	COVER, IGNITION COIL	11	30
52887	GUIDE, PUSH ROD - REVERSE LOCKING	39	14	73519A1	TILT STOP	55	44
52889	NOZZLE, TELL TALE HOSE TO BOTTOM COWL	29	14	73755A1	KNOB, CHOKE ROD	15	17
53078	CAP, PLASTIC - TILT TUBE	35	7	73984	YOKE, BOTTOM	33	15
53334	SEAL, SOUND ABSORBING - TOP	5	10	74257A3	PLATE ASSEMBLY, DRIVE SHAFT HOUSING	31	15
53665	INSERT, THROTTLE COUPLING	15	12	74406	BRACKET, MOUNTING - STARTER SOLENOID	49	40
53720A2	THROTTLE PICK-UP BRACKET ASSEMBLY	15	10	74407	BRACKET, MOUNTING - STARTER SOLENOID	49	34
54196A6	CARRIER ASSEMBLY, "O" RING	27	5	74528	TUBE, TILT - CLAMP BRACKET TO SWIVEL BRACKET	35	4
54283A1	PLUNGER AND LINK ASSEMBLY, CHOKE SOLENOID	15	6	74897	BARREL, SPARK LINK TO TRIGGER	9	40
54293A4	CHOKE SOLENOID	15	1	75043	CAP, THUMB SCREW	35	3
55455	HOOK, TOP COWL LATCH - REAR	3	13	75282	THRUST HUB	45	75
55991	BATTERY LEAD (POSITIVE)	49	39	75296	MOUNT, RUBBER - UPPER	39	20
55992	BATTERY LEAD (NEGATIVE)	49	39	75299	MOUNT, RUBBER - LOWER	39	24
56349	SHAFT, REVERSE LOCK PIVOT	35	29	75778	PLATE, BAFFLE - EXHAUST MANIFOLD	25	18
56703	COLLAR, STARTER MOTOR	7	12	76039	CAM, SHIFT	45	49
56849	KNOB, COWL FRONT COVER FASTENING	5	2	76062A1	SHAFT ASSEMBLY, SHIFT - LOWER	43	39
57247	STOP, RUBBER - STARTER MOTOR	7	14	76369	SPACER, BOTTOM COWL (COWL FRONT COVER)	29	7
59071	COVER, FUEL INLET	21	15	76370	SHIELD, TOP COWL - REAR	3	6
60304A54	SHIFT SHAFT ASSEMBLY, UPPER	29	17	76385	TILT LOCK ASSEMBLY (PORT)	35	22
60437	MEGAPHONE, EXHAUST	31	19	76386	TILT LOCK ASSEMBLY (STARBOARD)	35	21
62351A1	RECTIFIER ASSEMBLY	11	7	76387	TUBE, TILT LOCK	35	23
63007	MOUNT, RUBBER - TOP COWL FRAME	3	18	76395A5	HYDRAULIC PUMP ASSEMBLY	49	1
63473	TUBE	35	20	76395A5	HYDRAULIC PUMP ASSEMBLY, COMPLETE	47	-
64505A1	RETAINER ASSEMBLY, PISTON	57	12	76509A3	TRIM CYLINDER ASSEMBLY	53	1
64507A1	REPAIR KIT	57	-	76867	COVER, STARTER MOTOR BRACKET - BOTTOM	23	13
65638	BOOT, TUBE MOUNT	39	8A	77013A1	SWIVEL ASSEMBLY, SPARK LINK	9	34
65799	LINK, LOCKING LEVER TO COVER	29	29	77013A1	SWIVEL ASSEMBLY, THROTTLE LEVER	9	11
65800	"O"RING, CARRIER	27	6	77103A3	BRACKET ASSEMBLY, TOP COWL - FRONT	3	29
66084	BRACKET, MOUNTING - SHOCK CYLINDER (PORT)	53	7	77520A1	BEARING CARRIER ASSEMBLY	45	64
66096A1	PLATE ASSEMBLY, EXHAUST EXTENSION	31	1	77669	PIN, MOUNTING TUBE	55	46
66517	RESTRICTION, CRANKCASE BLEED	23	3	78184	TUBE, EXHAUST	39	8
66530A6	FUEL PUMP ASSEMBLY	21	1	79479	PLATE, ELECTRICAL MOUNTING	11	1
66599A3	DIAPHRAGM ASSEMBLY	21	3	79897	FRAME, TOP COWL SUPPORT	3	16
68162A8	TRIGGER PLATE ASSEMBLY	7	9	79900	LEVER, THROTTLE	9	1
69259	TUBE, MOUNTING - TILT STOP	55	45	79903	HOUSING, THROTTLE - LOWER	9	22

PARTS INDEX

Part Number	Description	Pg.	Ref. No.	Part Number	Description	Pg.	Ref. No.
85300	LINK ROD, THROTTLE	9	16	10-24942	SCREW	53	34
85301	SPARK LINK	9	39	10-25158	SCREW, ADJUSTING - LOWER HOUSING (1 1/2")	9	31
85441	THROTTLE CAM	9	18	10-25299	SCREW, CHOKE SOLENOID (3/4")	15	4
85943A1	LEVER, THROTTLE (UPPER CARBURETOR)	15	7	10-25764	SCREW, MERCURY SWITCH TO PLATE (5/8")	11	5
86295	BASE, FUEL PUMP	21	13	10-25764	SCREW, RECTIFIER TO IGNITION PLATE (5/8")	11	8
86316	COVER, EXHAUST MANIFOLD	25	20	10-26251	SCREW, SWITCH BOX TO IGNITION COIL (7/8")	11	26
86472	BRACKET, TOP COWL SUPPORT - REAR	3	20	10-28200	SCREW	33	12
86473	COVER, STARTER MOTOR BRACKET - TOP	23	9	10-28239	SCREW, THROTTLE HOUSING	9	25
86967	PLATE, RETAINING - LIMIT SWITCH CAM	53	26	10-28634	SCREW, FILLER - HYDRALIC PUMP	47	8
87872	COVER, TRANSFER PORT	25	30	10-28634	SCREW, FILLER - HYDRAULIC PUMP	49	3
87937	SHAFT, THROTTLE AND SPARK ADVANCE	9	24	10-28636	SCREW	25	32
87990	CHAMBER, PULSE - FUEL PUMP	21	14	10-28636	SCREW, PLATE TO CYLINDER BLOCK (3/4")	11	2
87991	POINTER, TIMING	3	37	10-28636	SCREW, TIMING POINTER ATTACHING (3/4")	3	38
N.S.S.	"O" RING (1 1/2" X 1 1/5" X 1/16")	57	1	10-28667	SCREW, PLATE TO CYLINDER BLOCK (1")	11	2
N.S.S.	"O" RING (1 1/4" X 1 7/16" X 1/16")	57	4	10-29256	SCREW	39	36
N.S.S.	"O" RING (1 3/4" X 1 15/16" X 1/8:)	57	9	10-29722	SCREW, COVER TO LOWER CLAMP MOUNT	39	39
N.S.S.	"O" RING (1 5/16" X 1 1/2" X 1/8")	57	7	10-30720	SCREW	41	29
N.S.S.	"O" RING (1 5/8" X 1 13/16" X 1/8")	57	6	10-32293	SCREW, CRANKCASE TO CYLINDER BLOCK (1 3/4")	23	17
N.S.S.	"O" RING (1 7/8: X 2: X 1/8")	57	8	10-32417	SCREW, FLYWHEEL PLATE	7	5
N.S.S.	"O" RING (3/4" X 15/16" X 1/8")	57	2	10-32866	SCREW, INLET COVER TO BOAT (2")	53	38
N.S.S.	"O" RING (5/8" X 3/4" X 1/16")	57	3	10-34290	SCREW	51	43
N.S.S.	"O" RING (7/32" X 11/32" X 1/16")	57	5	10-37370	SCREW, FUEL FILTER COVER ATTACHING (5/8")	21	16
N.S.S.	PISTON, ROD - HEAVY DUTY	57	11	10-37370	SCREW, SHIELD TO TOP COWL (5/8")	3	7
N.S.S.	RETAINER, SCRAPER	57	14	10-37558	SCREW, RETAINER TO TOP COWL (1 1/4")	3	4
N.S.S.	ROD, SCRAPER	57	13	10-37559	SCREW, THROTTLE LEVER TO EXHAUST COVER	9	2
N.S.S.	SEAL, SLIPPER - PISTON	57	10	10-37562	SCREW, REAR BRACKET TO BOTTOM COWL (1")	3	27
10-20037	SCREW, RETAINER ATTACHING	21	12	10-37562	SCREW, REAR BRACKET TO FRAME (1")	3	24
10-20359	SCREW, CENTER MAIN BEARING LOCKING	23	20	10-37571	SCREW	31	5
10-20411	SCREW, VALVE BODY TO RESERVIOR	47	4	10-38257	SCREW, VENT - HYDRAULIC PUMP	47	7
10-20847	SCREW, THROTTLE STOP LEVER	17	18	10-38257	SCREW, VENT - HYDRAULIC PUMP	49	5
10-21140	SCREW	49	35	10-38601	SCREW, STARTER SOLENOID TO PLATE (1/2")	11	11
10-21937	SCREW, LOWER SHOCK PIN	37	32	10-45263	SCREW	53	8
10-22523	SCREW	15	29	10-45264	SCREW	53	4
10-22956	SCREW, REAR HOOK TO TOP COWL (7/8")	3	14	10-45265	SCREW, BLEED - SHOCK CYLINDER	53	2
10-22968	SCREW, CENTER MAIN BEARING CLAMPING	27	13	10-45328	SCREW	53	19
10-23015	SCREW	15	29				
10-24234	SCREW	29	30				
10-24234	SCREW	49	23				

PARTS INDEX

Part Number	Description	Pg.	Ref. No.	Part Number	Description	Pg.	Ref. No.
10-45775	SCREW, MAIN BEARING CLAMPING	27	17	10-69034	SCREW, END CAP MOUNTING (1")	25	12
10-47255	SCREW	53	31	10-69035	SCREW, CABLE TO STARTER MOTOR	7	16
10-47828	SCREW, DRIVE - SWIVEL BRACKET	33	6	10-69046	SCREW, IGNITION COIL COVER (2")	11	31
10-48408	SCREW	29	15	10-69052	SCREW, GROUND WIRE TO BOTTOM COWL	11	23
10-48408	SCREW, DRIP TRAY TO BOTTOM COWL (1/2")	29	4	10-69092	SCREW	3	30
10-48591	SCREW, SPACER TO BOTTOM COWL (1/2")	29	8	10-69092	SCREW	3	32
10-48591	SCREW, STRAP TO CHOKE ROD (1/2")	15	23	10-69100	SCREW, COVER MOUNTING (1")	25	25
10-49318	SCREW, LOWER MOUNT (5 1/2")	39	25	10-69268	SCREW, BOTTOM COVER ATTACHING (1 7/8")	23	14
10-49554	BOLT, STEERING ARM TO UPPER MOUNT (5 7/8")	33	18	10-69375	SCREW	37	41
10-52195	SCREW, FLOAT BOWL COVER	17	13	10-73013	SCREW, FUEL PUMP ATTACHING (1 1/2")	21	17
10-53016	SCREW, CRANKCASE TO CYLINDER BLOCK (1 1/4")	23	17	10-73169	SCREW, END CAP MOUNTING (1")	25	6
10-53167	SCREW	25	15	10-73657	SCREW, CRANKCASE TO CYLINDER BLOCK (1 1/2")	23	17
10-53576	SCREW, MANIFOLD COVER MOUNTING	25	21	10-75168	SCREW, ADJUSTING - LOWER HOUSING (2 1/4")	9	28
10-54803	SCREW, CONNECTING ROD	27	28	10-75168	SCREW, ADJUSTING - THROTTLE LEVER	9	8
10-56500	SCREW	49	14	10-75840	SCREW, STATOR ATTACHING (7/8")	7	8
10-57807	SCREW, TRIM COVER TO BOTTOM COWL	39	6	10-76196	SCREW, STRAP TO CHOKE KNOB (5/8")	15	20
10-57841	SCREW, CRANKCASE TO CYLINDER BLOCK (2 3/4")	23	17	10-77065	SCREW, TOP COVER ATTACHING (2")	23	10
10-60293	SCREW, THROTTLE LEVER	15	8	10-78492A1	THUMB SCREW ASSEMBLY	35	2
10-60480	SCREW	31	20	10-78495	SCREW, WASHER ATTACHING	35	2A
10-62204	SCREW, REED STOP MOUNTING	27	21	10-79953	SCREW, GREASE FILLER AND VENT HOLE	43	47
10-62568	SCREW, GROUND STRAP ATTACHING	39	6C	10-86885	SCREW, PLATE TO CYLINDER BLOCK (1 1/2")	11	2
10-62568	SCREW, GROUND STRAP ATTACHING (3/8")	25	34	11-20110	NUT	15	31
10-65210	SCREW	45	74	11-20110	NUT, CHOKE SHUTTER TO CARBURETOR STUD	15	27
10-66023	SCREW, ADAPTOR PLATE TO HOUSING PLATE (2")	31	8	11-20509	NUT, THROTTLE CABLE TO SWIVEL	9	7
10-66023	SCREW, HOUSING PLATE TO DRIVE SHAFT HGS. (2")	31	10	11-20509	NUT, THROTTLE LEVER SCREW	9	5
10-66024	SCREW, TRIM TAB TO GEAR HOUSING (1 3/4")	45	71	11-20664	NUT, LINK ROD	29	22
10-66104	SCREW, THROTTLE BRACKET MOUNTING	15	11	11-20696	NUT, SHOCK CYLINDER SCREW	53	21
10-68298	BOLT	35	13	11-21825	NUT, STARTER SOLENOID SCREW	51	45
10-68298	BOLT	53	9	11-21908	NUT, MOUNTING BRACKET SCREW	49	25
10-68298	BOLT, HYDRAULIC PUMP TO BOAT (3 1/4")	49	26	11-24656	NUT	49	37
10-68299	BOLT	35	13	11-25096	NUT, LOWER MOUNT SCREW	39	27
10-68513	SCREW	53	27	11-25269	NUT, STRAP STOP FASTENING SCREW	33	13
10-68997	SCREW, FLYWHEEL HUB	7	6	11-28770	NUT	3	36
10-69020	SCREW	11	19	11-28770	NUT	53	18
10-69028	SCREW	51	41				
10-69029	SCREW, ADAPTOR TO BOTTOM COWL (1 3/4")	21	33				
10-69029	SCREW, SUPPORT TO BOTTOM COWL (1 3/4")	29	11				

PARTS INDEX

Part Number	Description	Pg.	Ref. No.	Part Number	Description	Pg.	Ref. No.
11-29250	NUT	23	19	11-68219	NUT, STARTER SOLENOID		
11-29488	NUT, INLET COVER SCREW	55	40		TERMINAL (#10)	49	30
11-29489	NUT	39	32	11-68292	NUT, SOLENOID TERMINALS		
11-29598	NUT	3	23		(5/16 - 18)	11	16
11-29598	NUT, ADJUSTING SCREW	9	29	11-68292	NUT, STARTER SOLENOID		
11-29598	NUT, ADJUSTING SCREW	9	9		TERMINAL (5/16")	49	32
11-34932	NUT, POWERHEAD STUD	31	23	11-68411	NUT, CLAMP BRACKET		
11-34933	NUT	39	30		BOLT	35	15
11-34933	NUT	45	73	11-68411	NUT, HYDRAULIC PUMP		
11-34933	NUT, STEERING ARM BOLT				BOLT	49	27
	FASTENING	33	19	11-68411	NUT, MOUNTING BRACKET		
11-34933	NUT, UPPER MOUNT BOLT	39	23		BOLT	53	11
11-35521	NUT, LOWER MOUNT			11-69254	NUT, POWERHEAD STUDS		
	CLAMP COVER	39	38		(3/8-24)	39	11
11-35888	NUT, RUBBER MOUNT TO			11-72008	NUT, THROTTLE HOUSING		
	TOP COWL FRAME	3	19		SCREW	9	27
11-35888	NUT, WATER PUMP			12-20260	WASHER, GREASE FILLER		
	FASTENING SCREW	41	32		AND VENT HOLE SCREW	43	48
11-35921	NUT, PINION GEAR TO			12-20260	WASHER, SEALING - FILLER		
	DRIVE SHAFT	41	10		SCREW	47	9
11-36069	NUT, ADAPTOR SCREW	21	34	12-20260	WASHER, SEALING -		
11-36069	NUT, SUPPORT SCREW	29	11A		HYDRAULIC PUMP FILLER		
11-45076	NUT, IGNITION COIL				SCREW	49	4
	TERMINAL	11	32	12-20878	WASHER, INLET COVER		
11-45076	NUT, RECTIFIER				SCREW	55	39
	TERMINALS	11	9	12-22753	WASHER	23	18
11-45076	NUT, SWITCH BOX			12-25970	WASHER, POWERHEAD		
	TERMINAL	11	28		STUD	31	22
11-45076	NUT, WIRE TO MERCURY			12-25970	WASHER, POWERHEAD		
	SWITCH	11	6		STUDS	39	12
11-45774	NUT, MAIN BEARING			12-28196	WASHER, UPPER BUSHING		
	CLAMPING SCREW	27	18		RETAINER (INNER)	37	38
11-45774	NUT, SWIVEL	9	38	12-29245	WASHER	41	31
11-45774	NUT, SWIVEL TO THROTTLE			12-29245	WASHER, MEGAPHONE		
	LEVER	9	15		SCREW	31	21
11-45812	NUT, JAM - LIMIT SWITCH			12-29395	WASHER, THROTTLE LEVER		
	ADJUSTING STUD	53	24		SCREW	9	3
11-46438	NUT, STRAP TO CHOKE			12-30164	WASHER, WIRING HARNESS		
	ROD SCREW	15	24		CLAMP SCREW	11	21
11-46887	NUT, BEARING CLAMPING			12-30771	WASHER, COVER		
	SCREW	27	14		FASTENING KNOB		
11-46887	NUT, CHOKE ROD SPRING				(RUBBER)	5	3
	TO CARBURETOR STUD	15	35	12-31263	WASHER, UPPER MOUNT		
11-46887	NUT, LOWER SHOCK PIN				BOLT	39	22
	SCREW	37	33	12-33786	WASHER, SWIVEL	9	13
11-47661	NUT, JAM - PUSH ROD	39	16	12-33786	WASHER, SWIVEL	9	36
11-49091	NUT, CONNECTING ROD			12-35462	WASHER, LINK ROD	29	21
	SCREWS	27	29	12-35462	WASHER, THROTTLE		
11-52707	NUT, PROPELLER	45	77		HOUSING SCREW	9	26
11-52901	NUT, FLYWHEEL			12-35462	WASHER, TIMING POINTER		
	ATTACHING	7	2		SCREW	3	39
11-53153	NUT, REED STOP SCREW	27	22	12-36001	WASHER, WATER PUMP		
11-56041	NUT, TILT TUBE FASTENING	35	6		BODY FASTENING STUD	41	33
11-64015	NUT, STARTER MOTOR			12-37807	WASHER	53	20
	TERMINAL	7	19	12-38753	WASHER, PLATE SCREW	11	3
11-64809	NUT, CARBURETOR			12-45176	WASHER	39	31
	MOUNTING STUD	19	35	12-45176	WASHER	39	33
11-68219	NUT, ADJUSTING SCREW	9	32	12-45176	WASHER	45	72
11-68219	NUT, SOLENOID TERMINAL	15	3	12-47247	WASHER, NEEDLE		
					LOCATING	27	31

PARTS INDEX

Part Number	Description	Pg.	Ref. No.	Part Number	Description	Pg.	Ref. No.
12-47840	WASHER, RUBBER - UPPER MOUNT BOLT	39	21	13-26993	LOCKWASHER, CLAMP BRACKET STUD	35	10
12-49339	WASHER, LOWER MOUNT SCREW	39	26	13-26993	LOCKWASHER, FRONT SUPPORT BRACKET SCREW	3	33
12-52864	WASHER, CLAMP BRACKET TILT TUBE	35	5	13-26993	LOCKWASHER, REAR BRACKET SCREW	3	26
12-59378	WASHER, LOWER BUSHING RETAINER (INNER)	37	39	13-26993	LOCKWASHER, REAR SUPPORT BRACKET SCREW	3	28
12-59572	WASHER, COVER FASTENING KNOB (PLASTIC)	5	4	13-26993	LOCKWASHER, SOLENOID TERMINALS (5/16")	11	15
12-68229	WASHER, FLYWHEEL ATTACHING	7	3	13-26993	LOCKWASHER, TOP COVER SCREWS	23	11
12-68300	WASHER, CLAMP BRACKET BOLT (UPPER)	35	14	13-26995	LOCKWASHER, FLOAT BOWL COVER SCREW	17	15
12-68410	WASHER, CLAMP BRACKET BOLT (LOWER)	35	14	13-26996	LOCKWASHER	49	29
12-68410	WASHER, MOUNTING BRACKET BOLT	53	10	13-26996	LOCKWASHER, FUL PUMP ATTACHING SCREW	21	18
12-69342	WASHER, SWIVEL PIN - UPPER	33	4	13-26996	LOCKWASHER, RETAINING PLATE AND CAM SCREW	53	28
12-69374	WASHER	37	40	13-26996	LOCKWASHER, SOLENOID TERMINAL	15	2
12-69380	WASHER, SWIVEL PIN - LOWER	33	10	13-26996	LOCKWASHER, SOLENOID TERMINALS (#10)	11	13
12-70132	WASHER	25	16	13-26996	LOCKWASHER, THRU BOLT	47	18
12-74726	WASHER, THROTTLE LEVER SCREW	15	8A	13-26996	LOCKWASHER, WIRING HARNESS CLAMP SCREW	11	20
12-76388	WASHER, TILT LOCK (STARBOARD SIDE ONLY)	35	25B	13-29402	WAVE WASHER, SWIVEL	9	14
12-76805	WASHER, THRUST	45	62	13-29402	WAVE WASHER, SWIVEL	9	37
12-77674	WASHER, RUBBER - SHIFT SHAFT BUSHING	43	44	13-29720	WASHER, WAVE - LINK ROD	29	23
12-78493	WASHER, THUMB SCREW	35	2B	13-37371	LOCKWASHER, SHIELD SCREW	3	8
12-85303	WASHER, PLASTIC - THROTTLE CAM	9	21	13-39107	LOCKWASHER, MOUNTING BRACKET SCREW	49	24
13-26992	LOCKWASHER	3	22	13-39107	LOCKWASHER, RETAINER TO TOP COWL SCREW	3	5
13-26992	LOCKWASHER	49	15	13-69150	WASHER	35	25
13-26992	LOCKWASHER, GROUND WIRE SCREW	11	24	13-86498	WAVE WASHER, SHAFT	9	23
13-26992	LOCKWASHER, MOUNTING BRACKET SCREW	49	36	14-20091	TAB WASHER, BEARING LOCKING SCREW	23	21
13-26992	LOCKWASHER, MOUNTING BRACKET SCREW	51	42	14-31210	TAB WASHER, PROPELLER NUT	45	76
13-26992	LOCKWASHER, REAR HOOK MOUNTING SCREW	3	15	14-52700	TAB WASHER, GEAR HOUSING COVER	45	68
13-26992	LOCKWASHER, STARTER MOTOR TERMINAL	7	18	15-20085A1	SHIM, END CAP TO CRANKCASE (.005-10)	25	11
13-26992	LOCKWASHER, STARTER SOLENOID SCREW	11	12	15-30923A1	SHIM	45	53
13-26992	LOCKWASHER, STARTER SOLENOID SCREW	51	44	15-57007A1	SHIM, BALL BEARING TO BASE	41	11
13-26992	LOCKWASHER, WATER PUMP BODY SCREW	41	30	15-73644A1	SHIM, END CAP TO CRANKCASE (.006-10)	25	5
13-26993	LOCKWASHER	3	31	16-21085	STUD, ADJUSTING - CUT-OUT LIMIT SWITCH (15/16")	53	23
13-26993	LOCKWASHER	3	35	16-30667	STUD	41	6
13-26993	LOCKWASHER	49	31	16-39937	STUD, CHOKE ROD SPRING TO CARBURETOR	15	33
13-26993	LOCKWASHER	53	17	16-45282	STUD, MOUNTING BRACKET AND CLAMP BRACKET	53	16
13-26993	LOCKWASHER, BOTTOM COVER SCREW	23	15				

PARTS INDEX

Part Number	Description	Pg.	Ref. No.	Part Number	Description	Pg.	Ref. No.
16-56295	STUD	39	2	22-64704	FITTING, ELBOW - UPPER		
16-56297	STUD	41	5		CARBURETOR	21	22
16-57920	STUD	41	4	22-64704	FITTING, FUEL OUTLET ...	21	19
16-57921	STUD	41	3	22-64706	FITTING, TEE - CENTER		
16-59625	STUD, CLAMP BRACKET ..	35	9		CARBURETOR	21	24
16-64280	STUD, CARBURETOR			22-67892	PLUG, DRAIN (MAGNETIC) .	43	47
	MOUNTING (1 3/16")	23	4	22-68307	PLUG, PIPE - CYLINDER		
16-64281	STUD	23	5		BLOCK COVER	25	27
16-64282	STUD	23	8	22-73318	TEE, FUEL LINE	21	23
16-69037	STUD, CARBURETOR -			22-74036	FITTING, GREASE - SWIVEL		
	CHOKE SHUTTER PIVOT	15	26		BRACKET	33	7
17-20032	DOWEL PIN, CENTER MAIN			22-74036	GREASE FITTING	53	1A
	BEARING	27	8	22-78279	ELBOW, TELL TALE HOSE		
17-20032	DOWEL PIN, MAIN BEARING	27	16		TO CYLINDER BLOCK ...	29	16
17-20033	PIN, DOWEL - CRANKCASE			22-85578	TEE, BALANCE HOSE	23	30
	TO CYLINDER BLOCK ...	23	6	22-85822A1	CONNECTOR ASSEMBLY,		
17-23784	DOWEL PIN, EXHAUST				SPEEDOMETER	41	1A
	EXTENSION PLATE	31	6	23-26600	BUSHING, SHIFT SHAFT ...	29	18
17-23784	DOWL PIN, DRIVE SHAFT			23-26856	BUSHING, SWIVEL	9	12
	HOUSING PLATE	31	17	23-26856	BUSHING, SWIVEL	9	35
17-29077	ROLL PIN, TENSION SPRING			23-27132	BUSHING, NYLON -		
	TO KNOB	5	6		EXHAUST EXTENSION		
17-30632	PIN, CROSS - RATCHET TO				PLATE	31	2
	PROPELLER SHAFT	45	58	23-28198	BUSHING, RUBBER - SHOCK		
17-35973	DOWEL PIN	41	19		ABSORBER (LOWER) ...	37	36
17-38311	PIN, COIL SPRING			23-28688	SPACER, RUBBER - COIL		
	MOUNTING	35	18		SPRING POSITING	35	19
17-46912	DOWEL PIN, GEAR			23-29804	SLEEVE, GUIDE - WATER		
	HOUSING LOCATING ...	41	2		INLET TUBE	41	36
17-47175	PIN, LOCKING LEVER AND			23-32171	BUSHING, RUBBER - SHOCK		
	COVER FASTENING	29	27		ABSORBER (UPPER)	37	35
17-47246	DOWEL PIN, STEPPED	27	12	23-32427	SPACER, CHOKE ROD		
17-49930A1	TILT LOCK PIN ASSEMBLY .	35	12		SPRING STUD	15	34
17-58998	PIN, ROLL - COWL LATCH			23-35977	GROMMET, RUBBER - LIFT		
	LEVER TO HINGE	3	12		HOSE AND TRIM HOSE ..	55	43
17-63779	PIN, DOWEL - CYLINDER			23-45280	SPACER, SHOCK CYLINDER		
	BLOCK TO MAIN BEARING	23	7		- LOWER	53	5
17-73593A1	SWIVEL PIN AND ARM			23-45281	BUSHING, RUBBER - SHOCK		
	ASSEMBLY	33	14		CYLINDER	53	6
18-25191	COTTER PIN, PUSH ROD			23-45354	BUSHING, RUBBER - CUT-		
	PIN	39	19		OUT LIMIT SWITCH	53	30
18-36391	COTTER PIN, MOUNTING			23-45818	BUSHING, THROTTLE		
	TUBE PIN	55	47		LEVER SCREW	9	4
18-45882	COTTER PIN, REVERSE			23-56774	SPACER, STARTER MOTOR	7	13
	LOCK TO SHAFT	37	30	23-59624	SPACER, CLAMP BRACKET		
18-47959	COTTER PIN, TILT LOCK ..	35	26		STUD	35	8
19-45907	PLUG, FLYWHEEL	7	1	23-69132	BUSHING, REVERSE LOCK		
19-64649	PLUG, PLASTIC - TRIM TAB				PIVOT SHAFT	33	2
	SCREW HOLE	39	3	23-69341	BUSHING, SWIVEL		
21-30430A10	CHECK VALVE ASSEMBLY .	21	2		BRACKET	33	3
21-77560	CHECK VALVE, BLEED			23-70412	SPACER, BALL BEARING TO		
	HOSE - UPPER	23	25		BASE	41	11
21-77561	CHECK VALVE, BLEED			23-73203	SPACER	37	37
	HOSE - LOWER	23	27	23-74213	SWIVEL, LINK ROD TO		
22-25885	ELBOW, BALANCE HOSE ..	23	28		THROTTLE CAM	9	17
22-46008	PLUG, CONTROL VALVE			23-77631A2	BUSHING ASSEMBLY, SHIFT		
	(1/2-20")	49	17		SHAFT	43	42
22-63981	ELBOW, FUEL LINE TO			24-20099	SPRING, LINK ROD TO		
	ADAPTOR	21	27		GUIDE BLOCK	29	31
				24-23067	SPRING, ADAPTOR STEM .	21	30

PARTS INDEX

Part Number	Description	Pg.	Ref. No.	Part Number	Description	Pg.	Ref. No.
24-24390	SPRING, TENSION - ADJUSTING STUD	53	22	26-38970	SEAL, RUBBER - WATER INLET TUBE	31	16
24-28659	SPRING, COIL - SWIVEL BRACKET	35	17	26-38970	SEAL, RUBBER - WATER INLET TUBE	41	26
24-28975	SPRING, GARTER - INTERNAL WIRING HARNESS	11	22	26-60898	SEAL, DRIVE SHAFT HOUSING PLATE	31	14
24-30622	SPRING, COMPRESSION - CAM FOLLOWER	45	52	26-70608	OIL SEAL, STARBOARD MOUNTING BRACKET	53	13
24-30772	SPRING, TENSION - FASTENING KNOB	5	5	26-76384	OIL SEAL, SHIFT SHAFT BUSHING	43	43
24-30893	SPRING, RETAINING - CROSS PIN	45	59	26-76868	OIL SEAL, BEARING CARRIER	45	66
24-35522	SPRING, TENSION - LOWER MOUNT CLAMP	39	35	27-32433	GASKET	41	20
24-45272	SPRING, TENSION - LIMIT SWITCH PLUNGER	53	15	27-32434	GASKET	41	22
24-48230	SPRING, CHOKE ROD TENSION	15	32	27-33146	GASKET, WATER PUMP BASE	41	14
24-57818	SPRING, UPPER FILTER SCREEN SCREW	15	30	27-45274	GASKET, INLET COVER	53	36
24-78203A1	SPRING, REVERSE LOCK TENSION	35	28	27-45275	GASKET, LIMIT SWITCH COVER	53	33
24-85442	SPRING, TORSION - SHAFT	9	20	27-48164	GASKET, CARBURETOR FLANGE	19	34
25-20116	GROMMET, CHOKE ROD	15	18	27-53862	GASKET, CRANKCASE TO CYLINDER BLOCK	23	2
25-20415	"O" RING, ADAPTOR STEM	21	31	27-62362	GASKET	31	18
25-21720	"O" RING, HYDRAULIC PUMP	47	1	27-66102	GASKET, PLATE TO DRIVE SHAFT HSG. PLATE	31	11
25-21720	"O" RING, HYDRAULIC PUMP TO MANIFOLD PLATE	49	2	27-69238	GASKET, POWERHEAD TO EXTENSION PLATE	31	7
25-21720	"O"RING	49	--	27-72142	GASKET, WATER JACKET COVER	25	14
25-21720	"O"RING	49	12	27-72506	GASKET, CYLINDER BLOCK COVER	25	24
25-25439	"O" RING, SHIFT SHAFT BUSHING	43	41	27-72507	GASKET, CYLINDER BLOCK TO BAFFLE PLATE	25	17
25-29976	"O" RING, BEARING CARRIER	45	63	27-72509	GASKET	25	19
25-30271	RING, RUBBER	41	35	27-85653	GASKET, TRANSFER PORT COVER	25	31
25-32546	"O" RING, END CAP	25	10	27-85653A79	GASKET SET	1	-
25-33145	"O" RING, WATER PUMP BASE	41	15	27-85653A79	GASKET SET	19	-
25-45016	"O" RING, SCHOCK CYLINDER BLEED SCREW	53	3	27-85653A79	GASKET SET	21	-
25-45253	"O"RING	49	13	27-85653A79	GASKET SET	23	-
25-45254	"O" RING	49	11	27-85653A79	GASKET SET	25	-
25-45507	GROMMET, RUBBER - INLET COVER	53	37	27-85653A79	GASKET SET	27	--
25-47254	"O" RING	25	4	27-85653A79	GASKET SET	31	-
25-57806	GROMMET, PLASTIC - TRIM COVER SCREW	39	6A	27-85653A79	GASKET SET	37	-
25-62702	"O" RING, TILT LOCK	35	25C	27-85653A79	GASKET SET	43	-
26-22734	OIL SEAL, SWIVEL BRACKET (TILT LOCK)	35	25A	27-85653A79	GASKET SET	45	-
26-29476	OIL SEAL, END CAP	25	3	28-30281	KEY, LOCATING - BEARING CARRIER	45	67
26-29476	OIL SEAL, END CAP	25	9	28-56654	KEY, IMPELLER DRIVE	41	28
26-31489	OIL SEAL, WATER PUMP BASE	41	17	29-47270	BEARING, NEEDLE - PISTON PIN	27	30
26-31507	OIL SEAL, WATER PUMP BASE	41	18	29-52168	BEARING, NEEDLE - OUTER RACE	27	9
				30-62567	BEARING, BALL - UPPER	27	3
				30-63742	BEARING, BALL -LOWER	27	4
				31-30894A1	TAPERED ROLLER BEARING ASSEMBLY	45	54
				31-30895	BEARING, ROLLER - FORWARD GEAR	45	55

PARTS INDEX

Part Number	Description	Pg.	Ref. No.	Part Number	Description	Pg.	Ref. No.
31-30956	BEARING, ROLLER -			53-26933	RING, SNAP - OUTER RACE	27	11
	BEARING CARRIER	45	65	53-29641	"E" RING, RETAINING -		
31-32898	BEARING, ROLLER - DRIVE				SHIFT SHAFT	43	40
	SHAFT	41	7	53-73591	RETAINING RING, BOTTOM		
31-62596A1	BEARING ASSEMBLY,				YOKE ATTACHING	33	16A
	CRANKPIN	27	27	54-61001	CLAMP, TRIGGER HARNESS	7	10
31-69220	ROLLER BEARING, DRIVE			54-63153	CLIP, HARNESS TO COIL		
	SHAFT	41	12		COVER	13	39
32-34395A1	HOSE	29	13	54-68424	CLAMP, FUEL LINE		
32-34395A1	HOSE, BALANCE - MAIN				ATTACHING	21	21
	BEARING (6 1/4")	23	29	54-76368	CLAMP, WIRING HARNESS		
32-34395A1	HOSE, DRIP TRAY TO				TO BOTTOM COWL	11	18
	BOTTOM COWL (8")	29	5	55-28414	PIN, LOWER SHOCK		
32-45327	HOSE	55	41		MOUNTING	37	31
32-45959	HOSE	55	42	55-28416	PIN, UPPER SHOCK		
32-54936	HOSE, BLEED (22")	23	26		MOUNTING	35	16
32-60897	TUBE, WATER INLET	39	7	55-58780A2	SHOCK ABSORBER	37	34
32-70432	FUEL LINE	21	20	84-60466A1	CABLE ASSEMBLY,		
32-70432	FUEL LINE, ADAPTOR TO				IGNITION COIL (BLACK)	11	33
	FUEL PUMP (16")	21	26	84-62310A3	CABLE ASS'Y	11	27
33-68057	SPARK PLUG (CHAMPION			84-66008A1	WIRE ASSEMBLY	7	15
	#L76-V)	13	37	84-73451A8	CABLE, HIGH TENSION	11	34
34-56007A1	REED SET, MATCHED -			84-73453	WIRE ASSEMBLY	7	17
	MAIN BEARING	27	19	84-74023	CONNECTOR AND		
34-56008	REED STOP, MAIN BEARING				HARNESS	49	18
	REED VALVES	27	20	84-85532	WIRING HARNESS,		
35-57819	SCREEN ASSEMBLY,				INTERNAL	11	17
	FILTER - CARBURETOR	15	28	84-85537A1	HARNESS ASSEMBLY	13	38
35-59072	SCREEN, FUEL INLET	21	8	84-85537A2	HARNESS ASSEMBLY	13	38
37-86432A79	DECAL SET	1	-	85-71006A1	PROTECTOR, HIGH		
39-78811A12	RING, PISTON	27	--		TENSION CABLE	11	36
39-78816A12	RING, PISTON	27	25	85-78866	INSULATOR, STARTER		
40-52035	LOCK RING, PISTON PIN	27	24		SOLENOID	13	40
43-68447	FORWARD GEAR	45	56	87-33386A2	SWITCH ASSEMBLY,		
43-68548	GEAR, PINION - DRIVE				MERCURY	11	4
	SHAFT	41	9	89-68258	STARTER SOLENOID	49	28
43-76250	REVERSE GEAR	45	61	89-76545	SOLENOID, STARTER	11	10
44-52542	SHAFT, PROPELLER	45	60	90-86153	MERC 90 PARTS LIST	1	-
45-42646	DRIVE SHAFT	41	8	92-25234--1	GLUE, ADHESIVE -		
46-64141A1	WATER PUMP BODY				BLANKET FASTENING	5	--
	ASSEMBLY	41	23	92-27109--1	ADHESIVE COMPOUND,		
46-73804A1	WATER PUMP BASE				EMBLEM FASTENING	5	--
	ASSEMBLY	41	16	248-5977A28	FLYWHEEL, ASSEMBLY,		
47-65960	IMPELLER, WATER PUMP	41	27		COMP.	7	4
48-77338A4	PROPELLER ASSEMBLY			332-2854	BOOT, HIGH TENSION		
	(ALUMINUM)(PITCH 11")	58	-		CABLE	11	35
48-77340A4	PROPELLER ASSEMBLY			332-5524A1	SWITCH BOX ASSEMBLY	11	25
	(ALUMINUM)(PITCH 13")	58	-	338-4995A2	COIL ASSEMBLY, IGNITION	11	29
48-77342A4	PROPELLER ASSEMBLY			392-2529	SPRING SET, BRUSH		
	(ALUMINUM)(PITCH 15")	58	-		TENSION	47	16
48-77344A4	PROPELLER ASSEMBLY			392-2618	CAN, VALVE BODY	47	3
	(ALUMINUM)(PITCH 17")	58	-	392-2623	WASHER, THRUST -		
48-77346A4	PROPELLER ASSEMBLY				ARMATURE	47	10
	(ALUMINUM)(PITCH 19")	58	-	392-2936	VALVE BODY AND GEAR		
48-77348A4	PROPELLER ASSEMBLY				ASSEMBLY	47	2
	(ALUMINUM)(PITCH 21")	58	-	392-2937	SEAL, RESERVOIR TO		
48-77350A4	PROPELLER ASSEMBLY				VALVE BODY AND GEAR	47	5
	(ALUMINUM)(PITCH 23")	58	-	392-2938	BOLT SET	47	17
50-72467	STARTER MOTOR	7	11	392-2939	RESEVOIR ASSEMBLY	47	6
52-34239	RATCHET, SLIDING GEAR	45	57				

PARTS INDEX

Part Number	Description	Pg.	Ref. No.	Part Number	Description	Pg.	Ref. No.
392-2941	BRUSH SET, COMMUTATOR			1399-3794	JET, MAIN FUEL (.074)	17	28
	END PLATE	47	15	1399-97	LEVER, THROTTLE	17	17
392-2942	FIELD AND FRAME			1440-6625A3	CLAMP BRACKET		
	ASSEMBLY	47	12		ASSEMBLY	35	1
392-2943	ARMATURE, FIELD AND			1482-6386A4	SWIVEL BRACKET		
	FRAME	47	11		ASSEMBLY	33	1
392-2944	BALL, COMMUTATOR END			1573-5239A4	DRIVE SHAFT HOUSING		
	PLATE	47	13		ASSEMBLY	39	1
398-5454A8	STATOR ASSEMBLY	7	7	1655-7333A23	GEAR HOUSING ASS'Y	41	1
436-6646A2	CRANKSHAFT ASSEMBLY	27	1	1655-7333A23	GEAR HOUSING ASS'Y	45	1
535-5397A4	CENTER MAIN BEARING			1655-7333A24	GEAR HOUSING ASS'Y,		
	ASSEMBLY	27	7		COMP.	45	-
540-5266A5	MAIN BEARING ASSEMBLY,			1655-7333A24	GEAR HOUSING ASS'Y,		
	VALVE TYPE	27	15		COMP.(SEE NOT BELOW)	41	-
622-4850A3	CONNECTING ROD AND			2113-5631A4	COWL FRONT COVER		
	CAP ASSEMBLY	27	26		ASSEMBLY	5	1
745-6661A4	PISTON AND PISTON PIN			2114-5999	COWL, TOP (WITHOUT		
	ASSEMBLY	27	23		DECALS)	3	1
745-6696A2	PISTON AND PISTON PIN			2115-6462	COWL, BOTTOM	29	1
	ASSEMBLY	27	--	2136-4660A4	WRAP AROUND COWL		
852-7741A2	CYLINDER BLOCK AND				ASSEMBLY	5	11
	CRANKCASE ASSEMBLY	23	1	5734-	HOSE, ECONOMIZER	17	12
852-7741A2	CYLINDER BLOCK AND						
	CRANKCASE ASSEMBLY	25	1				
1023-5070	COVER, CYLINDER BLOCK	25	23				
1148-5410A1	END CAP ASSEMBLY,						
	LOWER	25	7				
1161-5940A2	END CAP ASSEMBLY	25	2				
1368-7469A1	CARBURETOR ASSEMBLY						
	(TOP)	15	9				
1368-7469A1	CARBURETOR ASSEMBLY						
	(TOP)	17	1				
1368-7469A3	CARBURETOR ASSEMBLY						
	(CENTER/BOTTOM)	15	9				
1368-7469A3	CARBURETOR ASSEMBLY						
	(CENTER/BOTTOM)	17	1				
1395-4540	SCREW, BODY (IDLE TUBE)	17	21				
1395-4541	SCREW, PLUG - MAIN FUEL						
	JET CHANNEL	17	29				
1395-4542	SCREW, PLUG - MAIN						
	NOZZLE	17	27				
1395-4543	SCREW, BODY CHANNEL	17	32				
1395-4555	INLET NEEDLE, SEAT AND						
	GASKET	17	6				
1395-4804	SCREW, FLOAT BOWL						
	COVER	17	14				
1395-4808	GASKET AND PACKING SET						
	(1 PER CARBURETOR)	19	--				
1395-5108	SHUTTER, THROTTLE	17	22				
1395-5353	FLOAT ASSEMBLY	17	2				
1395-5680	COVER, FLOAT BOWL	17	10				
1395-5733	JET, BOWL VENT	17	11				
1395-6029	JET, MAIN FUEL (.068)	17	28				
1395-6030	JET, MAIN FUEL (.070) -						
	STANDARD	17	28				
1395-6207	JET, MAIN FUEL (.072)	17	28				
1395-7614	SHAFT, THROTTLE (TOP)	17	19				
1395-7628	REPAIR PARTS KITS (1 PER						
	CARBURETOR)	19	--				